

ASPHALT IN HYDRAULICS

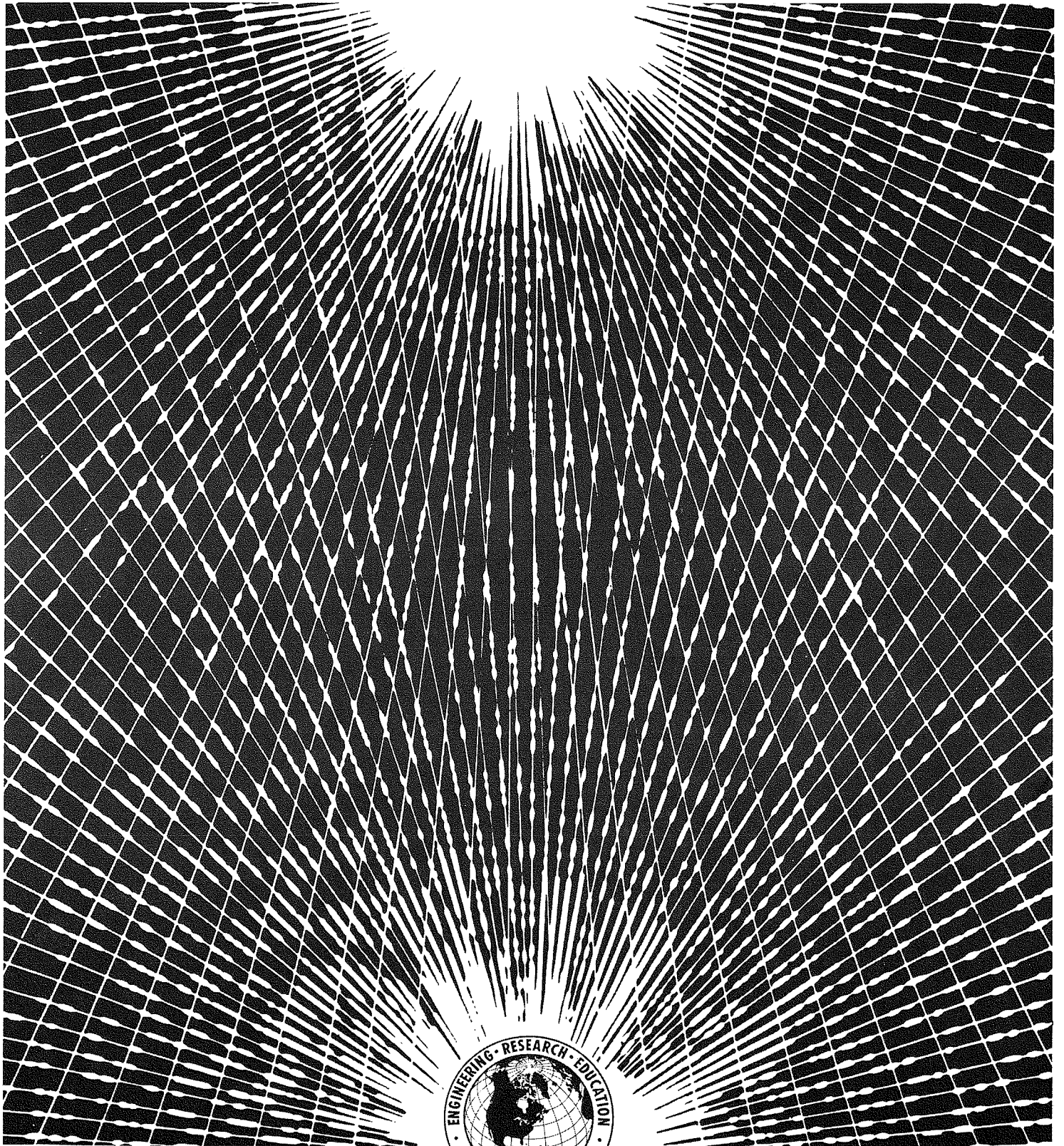

THE ASPHALT INSTITUTE
MANUAL SERIES NO. 12 (MS-12)
NOVEMBER 1976

PRINTED IN USA

FOREWORD

This publication has been prepared to assist engineers in design and construction procedures for the use of asphalt in hydraulic structures. Much of the technology in this field has been made available only in conference proceedings, papers, miscellaneous articles, or by a few engineers. This manual presents general principles and examples of construction based on various publications and experiences.

The principal difference between this edition and the first edition, published in 1961, is the organization of the material. It also includes some significant projects or innovations that have come about since the first edition appeared. Finally, certain examples in the first edition no longer merit emphasis and have been deleted.

The use of asphalt in hydraulic structures has expanded widely during the past 40 years and is expected to continue as new materials and techniques are proven in service, particularly in attempts to prevent pollution of water supplies. This manual must be considered as a compilation of presently available knowledge in the use of asphalt. Future revisions will be published as necessary to keep pace with the continuing development of technology in this field.

**THE ASPHALT INSTITUTE
ASPHALT INSTITUTE BUILDING
COLLEGE PARK, MARYLAND 20740**

TABLE OF CONTENTS

Page

<i>Foreword</i>	iii
<i>List of Illustrations</i>	vii
<i>List of Tables</i>	ix

PART I: GENERAL PRINCIPLES

CHAPTER I: EARLY HISTORY AND CURRENT TERMINOLOGY	1
A. Asphaltic Materials	1
B. Hydraulic Structures	3
CHAPTER II: CONSIDERATIONS FOR USING ASPHALT	5
A. Asphalt Materials for Hydraulic Structures	5
B. Design Considerations	8
CHAPTER III: TYPES OF ASPHALT APPLICATIONS	13
A. Impermeable Asphalt Concrete Linings	13
B. Porous Hot-Mix Asphalt Linings	16
C. Asphalt Mastic Mixes	16
D. Surface Treatments	18
E. Buried Asphalt Membrane	19
F. Prefabricated Asphalt Panels	21
G. Miscellaneous	22

PART II: EXAMPLES OF APPLICATIONS

CHAPTER IV: ASPHALT IN RESERVOIRS AND DAMS	27
A. Asphalt Linings for Reservoirs	27
B. Asphalt in Dam Construction	33
CHAPTER V: ASPHALT IN CANALS AND DRAINAGE CHANNELS	41
A. Canals	41
B. Drainage Channels	43
CHAPTER VI: ASPHALT IN BANK PROTECTION	45
CHAPTER VII: ASPHALT IN COAST-PROTECTION STRUCTURES	49
CHAPTER VIII: ASPHALT IN MISCELLANEOUS USES	55
<i>Index</i>	61
<i>List of Asphalt Institute Member Companies</i>	67
<i>List of Asphalt Institute Engineering Offices</i>	67

LIST OF ILLUSTRATIONS

<i>Figure</i>		<i>Page</i>
I-1	Upper Reservoir of the Ludington, Michigan pumped-storage project	xii
I-2	Construction of the Tigris Embankment at Assur (1300 B. C.)	1
I-3	Comparison of Penetration Grades and Viscosity Grades of Asphalt Cement	2
II-1	San Joaquin Reservoir, Orange County, California	4
II-2	Designs for Top, Bottom, and Toe of Asphalt Paved Linings and Facings	10
III-1	Asphalt Hot-Mix Being Lowered to Paver on Homestake Dam, Colorado	12
IV-1	Construction of Asphalt Concrete Lining on Innerste Dam, Germany	26
IV-2	Asphalt Paving Machine Hoisted on Special Ramp for Repositioning, Garvey Reservoir, California	26
IV-3	Spreader Box Mounted on Arms of Front-End Loader, San Joaquin Reservoir, California	26
IV-4	Simplified Typical Cross-Section of Reservoir Lining Used in Earlier Construction, EBMUD, California	29
IV-5	Typical Cross-Section of Reservoir Lining Developed by EBMUD, California	29
IV-6	Cross-Section of Asphalt Lining, Eastern Reservoir, Onondaga County, New York	29
IV-7	Asphalt Paving Machine Spreading Asphalt Mix, Eastern Reservoir, Onondaga County, New York	30
IV-8	Cross-Section of Reservoir Lining, Upper Reservoir, Seneca Power Project, Pennsylvania	31
IV-9	Typical Embankment Section for Ludington Pumped-Storage Reservoir, Michigan	31
IV-10	Typical Cross-Section of the Watertight Lining, Ludington Pumped-Storage Reservoir, Michigan	31
IV-11	A Pair of Specially Designed and Built Paving Units Placing the Initial Paving Course, Ludington Pumped-Storage Reservoir, Michigan	33
IV-12	Workman Recompressing Paving Joint, Ludington Pumped-Storage Reservoir, Michigan	33
IV-13	Alternate Asphalt Courses for Dams	33
IV-14	Cross-Section of Toe of Montgomery Dam, Colorado	35

LIST OF ILLUSTRATIONS (CONTINUED)

<i>Figure</i>		<i>Page</i>
IV-15	Paving Operations, Montgomery Dam, Colorado	35
IV-16	Cross-Section of Upstream Face of Homestake Dam, Colorado	36
IV-17	Modified Paving Machine Placing Leveling Course on Homestake Dam, Colorado	36
IV-18	Vibratory Roller with Modified Frame for Compacting the Asphalt Concrete Facing, Homestake Dam, Colorado	36
IV-19	A Heavy Vibrator Forcing Stones into the Hot Asphalt Mastic Core	38
IV-20	Front View of Special Machine for Asphalt Core Construction	38
IV-21	Rear View of Special Machine for Asphalt Core Construction	38
IV-22	Longitudinal Cross-Section of Asphalt Cutoff Wall, Claytor Dam, Virginia	39
V-1	Construction of Asphalt Lining on Canal Alimentadore del Norte, Baja California, Mexico	40
V-2	Lining a Canal with a Slip-Form Paver	42
V-3	Cross-Section of Buried Asphalt Membrane-Lined Canal	42
V-4	Lining Ditch with Prefabricated Asphalt Panels	43
VI-1	Roller Operated by a Drag Line Compacts the Asphalt Revetment, San Joaquin River, California	44
VI-2	Placing Mix by Spreader Box	46
VI-3	Typical Section of the Compacted Asphalt Concrete Section, San Joaquin River, California	47
VI-4	Typical Cross-Section of Asphalt-Grouted Gabion Mattress, Bristol Channel, South Wales, United Kingdom	48
VII-1	Asphalt Jetty Affords Excellent Protection to Sandy Beach, Asbury Park, New Jersey	48
VII-2	Cross-Section, South Jetty, Galveston, Texas	50
VII-3	Galveston Jetty After Fifteen Years of Service	50
VII-4	Asphalt-Capped Cellular Breakwater, Port Austin, Michigan	50
VII-5	Drawing of the Asphalt Ship "Jan Heymans" Showing the Mixing Plant and Special Underwater Mastic Placing Apparatus	52
VII-6	Horizontal Distributor for Placing the Asphalt Mastic Underwater	52
VII-7	Asphalt-Capped Seawall, Palos Verdes Estates, California	52
VII-8	Seawall Slope Revetment	53
VIII-1	Asphalt-Lined Brine-Storage Reservoir, Lapeer County, Michigan	54
VIII-2	Placing the Binder Course on the Wallingford Swimming Pool, Connecticut	56

LIST OF ILLUSTRATIONS (CONTINUED)

<i>Figure</i>		<i>Page</i>
VIII-3	Placing Asphalt Membrane Lining, Rocky Mountain Arsenal	57
VIII-4	Asphalt-Lined Pool, General Motors "Futurama" Exhibit at the 1964-65 World's Fair	58
VIII-5	Prefabricated Asphalt Panel Lined Reflecting Pool, City Water Department, Long Beach, California	58
VIII-6	A Beautiful Asphalt Panel Lined Pond in Scherer Park, Long Beach, California	59
VIII-7	Asphalt Lined Lagoon, Deering-Milliken Research Center, Spartanburg, South Carolina	59
VIII-8	Pavement Cross-Section of Asphalt Paved Recovery Pad for Leaching Copper, Butte, Montana	59
VIII-9	Spraying Asphalt Membrane Seal Over Asphalt Concrete Paved Basin for Leaching Gold, Cortez, Nevada	60

LIST OF TABLES

<i>Table</i>		<i>Page</i>
II-1	Application Forms of Asphaltic Materials for Hydraulic Structures	6
III-1	Mix Composition for Formed-in-Place Asphalt Linings	15
III-2	Requirements for Asphalt for Use in Waterproof Construction	20
V-1	Minimum Recommended Asphalt Concrete Canal Lining Thicknesses	41

PART I:
GENERAL PRINCIPLES

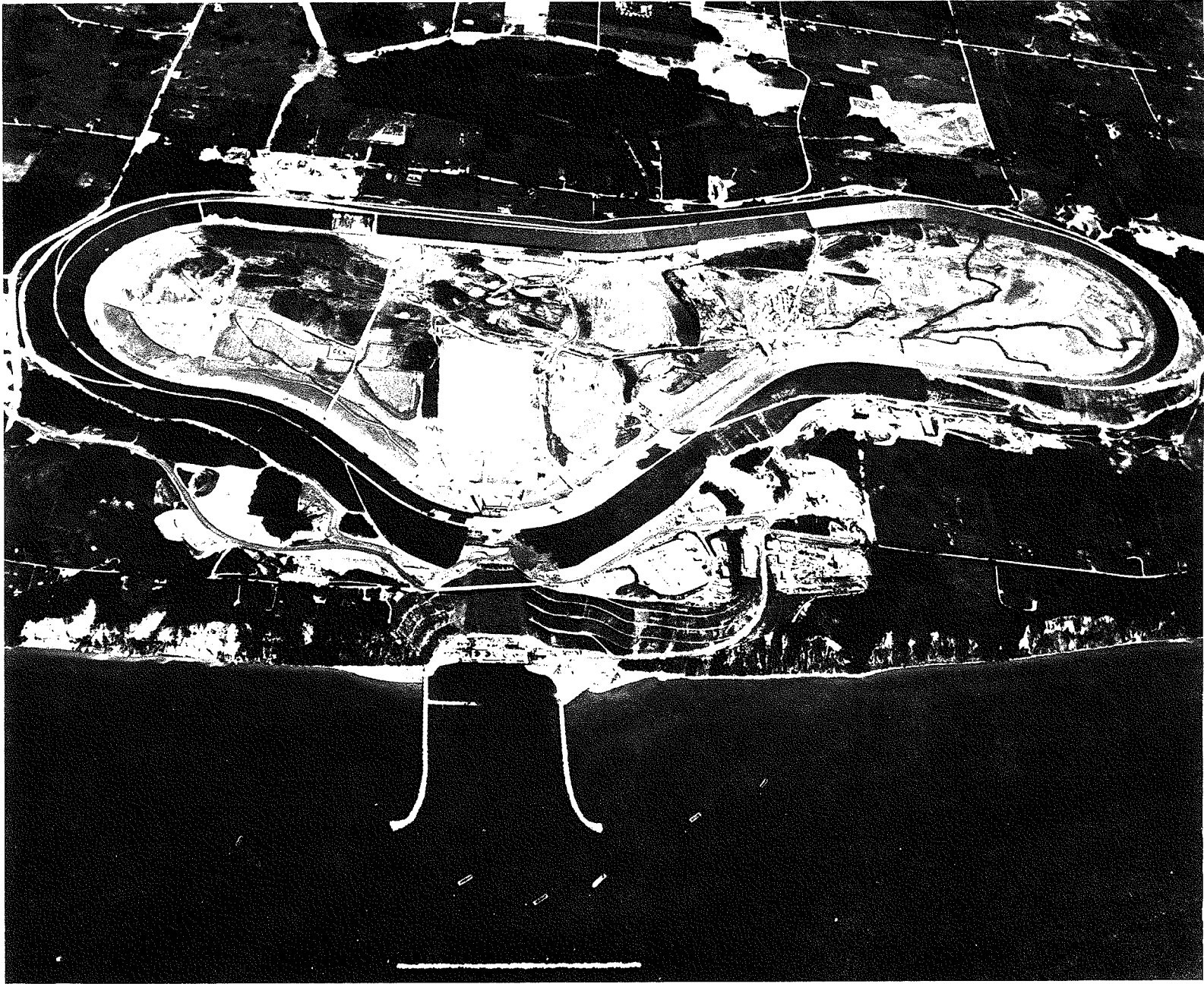

FIGURE I-1. Upper reservoir of the Ludington, Michigan, pumped-storage project; (photo courtesy Civil Engineering-ASCE)

CHAPTER I

EARLY HISTORY AND CURRENT TERMINOLOGY

1.01 EARLY HISTORY AND BACKGROUND--

Recent archeological excavations in Mesopotamia and in the Indus Valley show that asphalt was used as a waterproofing layer for temple baths and water tanks nearly 5,000 years ago. About 1300 B. C., Mesopotamians built a levee along the banks of the Tigris River at Assur with limestone blocks mortared with asphalt mastic and faced with bricks bonded and waterproofed with asphalt mastic (see Figure I-2). In the sixth century, B. C., Sennacharib, king of Assyria, built a canal 80 km (50 miles) long with limestone blocks and asphalt mastic to bring water to his capital. He constructed weirs, transformed a gorge into a reservoir, erected aqueducts, and lined the canal. The fact that some of these structures are still in existence attests to the strength and durability of asphalt.

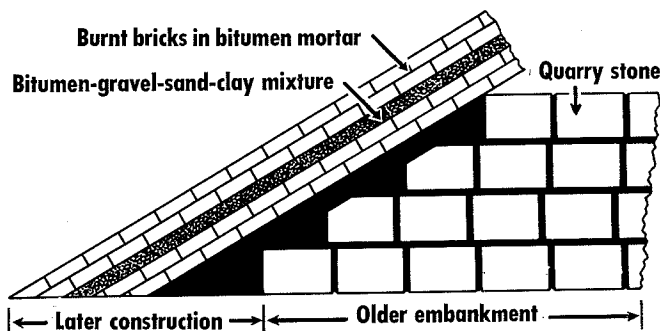

FIGURE I-2. Construction of the Tigris Embankment at Assur (1300 B.C.).

Our present concern, however, is with developments of the past four decades, during which there has been progressive expansion in the use of asphalt for the control, conservation and storage of water. This period has seen development of proven procedures for the use of asphalt in revetments, linings for canals and reservoirs, heavy facings for dams, in grouting, and in other hydraulic structures. It is certain that asphalt usage will continue to expand as technology in this field advances.

This technology must keep pace with the growing importance of:

- Water conservation, to meet the increasing demand on existing water supplies.
- Pollution control, to prevent waste-laden waters from contaminating streams and groundwater supplies.
- Irrigation, to open up new lands for cultivation.
- Flood control, to protect lives and investments in personal property and industry.
- Beach erosion control, to preserve beaches and protect waterfront property.

1.02 TERMS RELATING TO ASPHALT AND ITS USES IN HYDRAULIC STRUCTURES--

A. ASPHALTIC MATERIALS

Asphalt Cement--Asphalt that is refined to meet specifications for paving, industrial, or special purposes.

For many years asphalt cement has been graded on the basis of the penetration test, an empirical measure of consistency. Recently, however, the penetration grading of asphalt cements has been replaced by the more fundamental viscosity grading.

Two systems of viscosity grading are currently used. The AC system is based on the viscosity of the original asphalt cement. The AR system, used mostly in the Pacific Coast states of the United States, is based on the viscosity of the residue of the asphalt cement after it has been subjected to hardening conditions approximating those occurring in normal hot-mix plant operations.

The relationships between the various grading systems are shown in Figure I-3.

For purposes of this publication, unless describing a particular project, the AC-grading system is used. Figure I-3 should

facilitate conversion, if necessary, to the locally-specified asphalt cement.

Asphalt Concrete, Hydraulic Type-- Similar to asphalt concrete for roadway paving, except, to ensure an essentially voidless mix after compaction, higher mineral filler and asphalt contents are used.

Asphalt Facing--An asphalt surface designed to resist erosion, abrasion, water pressure, and in some instances, ice pressure. A facing may, in addition, also act as an impermeable layer to prevent leakage through the structure. It may also be termed an *asphalt lining* or *asphalt revetment* (see below).

Asphalt Grout--A mixture of asphalt, sand, and mineral filler which, when heated and mixed, will flow into place without mechanical manipulation.

It is used to bind together a layer of coarse stone of more or less uniform size.

It may also be termed *asphalt mastic* (see below).

Asphalt Injection--A pressurized sub-surface application of asphaltic material. Usually, injections are made for the purpose of filling subsurface cavities or crevices in the foundation soil, or voids beneath an existing pavement layer, primarily for controlling water seepage.

Asphalt Lining--That part of a hydraulic structure that functions as a durable, erosion-resistant surface. Usually, its most important function is as a waterproof barrier holding water or other liquid inside the structure.

Asphalt Mastic--A mixture of mineral aggregate, mineral filler and asphalt in such proportions that the mix can be applied hot by pouring or by mechanical manipulation; it forms a voidless mass without being compacted.

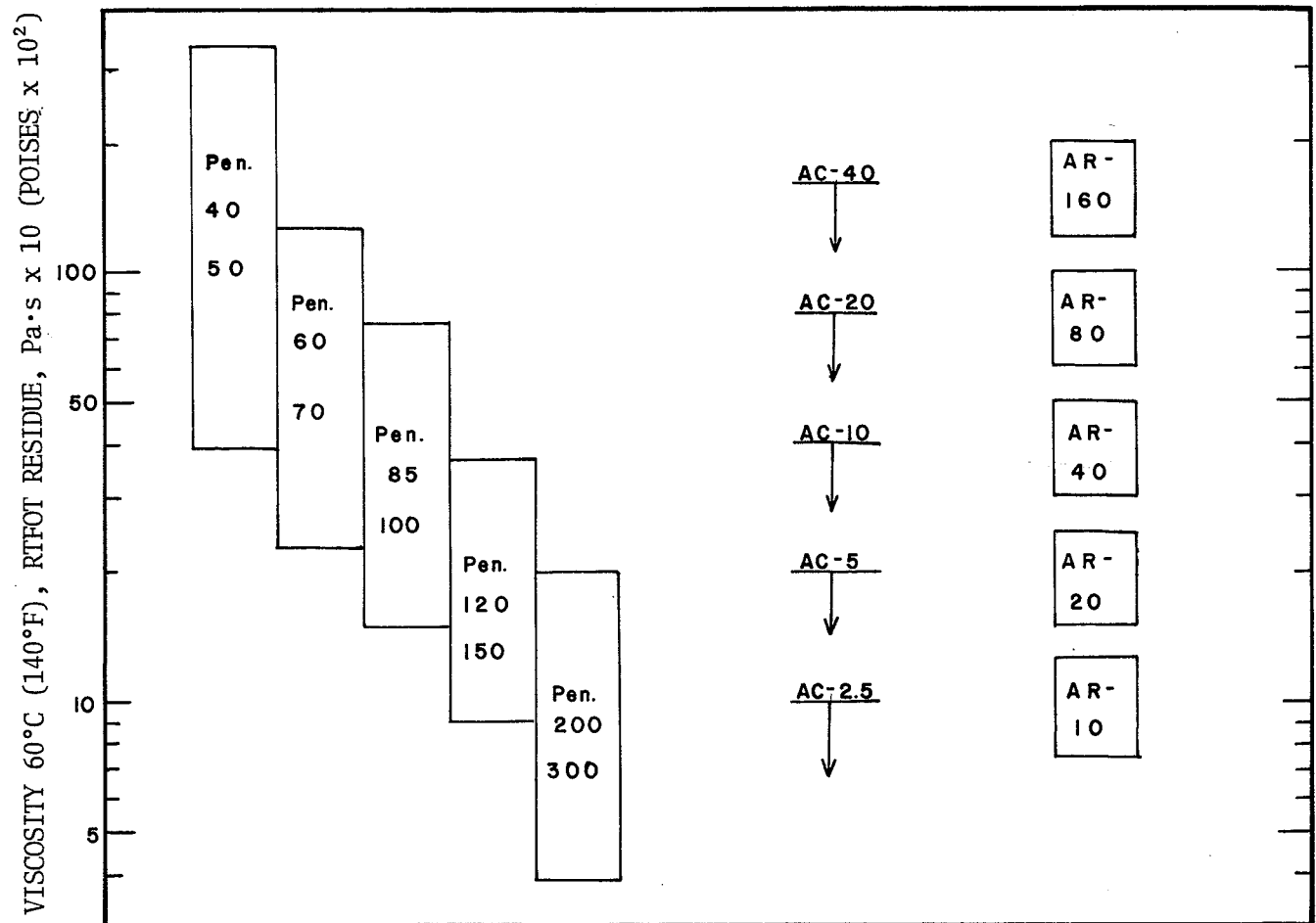

FIGURE I-3. Comparison of Penetration Grades and Viscosity Grades of Asphalt Cement (based on RTFOT Residue for AR-Grades and Pen.-Grades; TFOT Residue for AC-Grades).

Asphalt Mattress, Slab--Terms, according to size, denoting prefabricated flexible units composed of an asphalt mastic mixture reinforced with mesh, netting, lines, or cables as required.

Asphalt Membrane--A relatively thin layer of asphalt formed by spraying a high viscosity, high softening point asphalt cement in two or more applications over the surface to be covered. It is normally about 6 mm (1/4 in.) thick, and is used for waterproofing or sealing. It is buried to protect it from weathering and physical damage.

Asphalt Mat--A felt or fabric sheet impregnated or coated with asphalt to form a watertight lining or membrane usually 6 mm (1/4 in.) or less in thickness. It may be a sheet that is first installed in place with the asphalt applied following installation, or it may be a finished material that is watertight and ready for installation.

Asphalt Revetment--A protective asphalt facing on a sloped surface, usually placed for the purpose of protecting an embankment from erosion. Revetments may or may not extend all the way to either the toe or crest of the sloped embankment. The term *subaqueous* refers to that part of a revetment placed under the surface of the water. *Upper bank* paving is that portion placed above the surface of the water.

Impermeable Asphalt Mixes--Asphalt mixes having low voids, (usually less than 4 percent) after installation, designed to prevent the passage of water.

Porous Asphalt Mixes--Asphalt mixes that permit the free flow of water through the mix. Porous asphalt mixes are divided into two general classifications: *permeable asphalt mixes* and *open-graded asphalt mixes* (see below).

Permeable Asphalt Mixes--Asphalt mixes having medium voids after installation, designed to permit the free passage of water through the lining to and from the supporting layer or embankment.

Open-Graded Asphalt Mixes--Asphalt mixes having high voids, designed to provide a free drainage layer underneath an impermeable lining.

Prefabricated Asphalt Panels--A layer of a very dense mixture of asphalt and filler

sandwiched between two layers of some tough, asphalt-impregnated material and usually coated with waterproofing asphalt.

B. HYDRAULIC STRUCTURES

Breakwater--A structure protecting a shore area, harbor, anchorage, or basin from waves.

Canal--A water-course cut through a land area and used for either navigation or irrigation.

Catchment Basin--A large, very shallow reservoir-like area designed to collect rain water. It usually discharges the collected water into a storage tank or reservoir.

Causeway--A raised road across wet or marshy ground or across water.

Cavitation--The rapid formation and collapse of vapor pockets in flowing water in regions of very low pressure. It can cause structural damage to hydraulic linings.

Channel--A natural or artificial waterway that either periodically or continuously contains moving water, or that forms a connecting link between two bodies of water.

Dam--An artificial barrier of earth, rock, masonry, or other material across a channel to impound water or to obstruct its flow.

Dike--A wall or mound built around an area to impound water or to prevent flooding. If used to protect from flooding, it is usually termed a *levee* (see below).

Embankment--An artificial bank, mound, or dike built for a specific purpose, such as to hold back water, or to carry a roadway.

Groin--A shore-protective structure extending out from and perpendicular to the shoreline to trap littoral drift or retard shore erosion.

Jetty--A pier or structure of stone, rubble, or the like, projecting into the sea or other body of water to protect a harbor, or to influence water currents or tides.

Lateral--A small branch canal leading

off a main canal, usually for irrigating local areas.

Levee--A dike or embankment to protect a land area from flooding.

Pond--A body of still water smaller than a lake.

Reservoir--A place where water is collected and stored for future uses such as supplying a community, irrigating land, or furnishing power.

Riprap--A layer, facing, or protective mound of stones, randomly placed to prevent erosion, scour, or sloughing of a structure or embankment. It may also mean the stones so used.

Sanitary Landfill--An area of land designed for the disposal of refuse in accordance with sound engineering methods whereby the refuse is confined to the smallest practical area, reduced to the smallest possible volume, and covered with earth periodically.

Seawall--A structure separating land and water areas, primarily designed to prevent erosion and other damage by wave action.

Sewage Lagoon--A large, shallow reservoir or pond for the treatment of sewage or industrial waste. Treatment is accomplished by natural biological (aerobic) processes that require oxygen and sunlight.



FIGURE II-1. San Joaquin Reservoir, Orange County, California,

CHAPTER II

CONSIDERATIONS FOR USING ASPHALT

A. ASPHALT MATERIALS FOR HYDRAULIC STRUCTURES

2.01 PROPERTIES OF ASPHALT MATERIALS-- Asphalt has many properties that make it particularly suitable for use in hydraulic structures.

It is versatile in form and application. Asphalt can be used alone (as in an asphalt membrane), or it can be mixed with other materials producing mixes for a variety of purposes. It can be combined with graded aggregate to form a voidless and impermeable mix. On the other hand, it can be combined with an open-graded aggregate to form a porous mixture allowing free passage of water.

Asphalt is stable in the presence of nearly all chemically-laden substances. It is normally unaffected by the usual concentrations of acid, salt, and other waste solutions. This important characteristic makes it useful for waterproofing reservoirs. However, since asphalt is refined from petroleum, other petroleum-based products (which are solvents of asphalt) cannot be stored in asphalt-lined structures.

An important property of asphalt is its flexibility. This allows asphalt structures to conform to slight irregularities in the subgrade, and to adjust to small differential settlements that inevitably occur after the completion of a structure.

Asphalt is inert in the presence of water, to which it imparts neither taste nor odor. In order to ensure complete acceptability, health officials have made many tests of the hygienic qualities of drinking water stored in asphalt-lined structures. In all cases, the asphalt lining has received unqualified approval.

Asphalt's durability, underscored by the existence of some ancient structures constructed with asphalt, is quite high. It weathers only at the surface, and then only when exposed to sunlight or oxygen, or when it is subjected to physical attack such as extensive abrasion.

The physical properties of asphalt mixes are generally dependent upon stress conditions and temperature. The ingredients that comprise asphalt mixes have completely different characteristics. The mineral aggregate that makes up the major portion of the mix is mainly elastic. The asphalt portion, on the other hand, behaves as a viscous liquid at high temperatures or when subjected to sustained loads, and as an elastic material at low temperatures and under impact load; consequently, asphalt mixtures have both plastic and elastic properties.

2.02 TYPES OF ASPHALT MATERIALS AND THEIR FUNCTIONS--There are many types of asphaltic materials used in hydraulic applications. Each type can be classified in one of the following distinct categories:

- Impermeable asphalt mixes
- Porous asphalt mixes
- Asphalt mastics
- Asphalt cement
- Prefabricated asphalt materials.

These materials can be used in various forms to perform one or more of the following functions:

- To *waterproof* a structure
- To *protect* a structure
- To *reinforce* a structure.

Table II-1 shows how each type of asphalt material may be used to perform these various functions.

2.03 ASPHALT FOR WATERPROOFING--

Impermeable Mixes--The most common way of using asphalt to make a hydraulic structure watertight is to pave the surface with asphalt concrete which, when compacted, forms an impermeable lining. Asphalt mixes used for this purpose are generally similar to those used for roadway paving, and are prepared in an asphalt mixing plant. Standard roadway construction equipment is usually modified for this type of paving. In many instances, however, special paving equipment has been devised.

TABLE II-1
APPLICATION FORMS OF ASPHALTIC MATERIALS
FOR HYDRAULIC STRUCTURES

Material*	Function		
	Waterproof	Protect	Reinforce
Impermeable Asphalt Mixes	Surface or exposed linings	Surface or exposed linings	
Porous Asphalt Mixes		Permeable surface linings, Open-graded subsurface drainage layers	
Asphalt Mastics	Surface linings, Seal coats, Cutoff walls, Dam cores, Subsurface injection	Surface linings, Seal coats	Grouting, Penetration treatments
Asphalt Cement	Membranes, Seal Coats Subsurface pressure injections		Grouting, Penetration treatments
Prefabricated Asphalt Materials	Panels, Sheets, Mattresses, Slabs	Panels, Mattresses, Slabs	

* Specific details of the design, preparation, and installation of the asphalt materials are described in Chapter III.

Mastics--Asphalt mastics have also been used for constructing watertight linings, particularly in Europe and Africa. Asphalt mastics require little or no compaction after placing since the void spaces in the aggregate matrix are filled or slightly overfilled with asphalt. Asphalt mastics are generally screeded on asphalt linings in order to further waterproof the lining surface.

An underground cutoff wall consisting of an asphalt mastic constitutes an excellent watertight barrier. The mastic is sufficiently flexible to withstand some underground movement without cracking. Dams

having an internal core of asphalt mastic have been successfully used in Europe. They have been constructed in instances where a watertight lining on the upstream face was not economically feasible and, in some cases, when suitable clay was unavailable or otherwise impractical to use for this purpose.

Asphalt Cement--High softening point asphalt cement is often used to form an asphalt membrane. It is sprayed directly on the prepared ground surface to be protected. Asphalt membranes are usually covered with a layer of a suitable soil to

protect them against damage. The soil also serves as a surcharge to prevent displacement of the membrane by waves or water currents.

Seal coats of asphalt cement are sometimes used to seal the surface pores of linings to ensure watertightness. Another way in which asphalt is used for sealing is by dumping an emulsified asphalt into impounded water. As the water seeps into the soil, the asphalt clogs the surface pores and retards further leakage. In the United States this practice has only been tried experimentally to seal small canals or laterals.

Another way in which asphalt is used for waterproofing is pressure injection. Loss of water through underground fissures and cavities has been significantly reduced or eliminated by employing this technique. The asphalt, injected under high pressure, fills the cavities and fissures obstructing the flow of water. Both asphalt cement and emulsified asphalt, combined with mineral filler, have been used for this purpose. The principles of application are similar to those used by highway maintenance crews in undersealing operations. Asphalt mastics can also be designed for this purpose.

Prefabricated Materials--Prefabricated asphalt materials provide a relatively simple means of waterproofing a hydraulic structure. The most widely used lining material in this category is the prefabricated asphalt panel. It is composed of a layer of mineral matter and fibers mixed with asphalt sandwiched between two asphalt-impregnated layers. When installed, the panels are bound together tightly to form a completely watertight lining.

Prefabricated asphalt mats are similar in most respects to the panels, except that they are not as thick and therefore more flexible. However, they will not normally withstand the physical abuse that panels can endure.

Prefabricated asphalt mattresses and slabs are molded or precast layers of asphalt mastic generally reinforced with a wire or fabric net or even with cables to facilitate moving them into place without damage. These types of asphalt linings have been used to waterproof some European structures in much the same way as prefabricated asphalt panels are used.

2.04 ASPHALT FOR PROTECTION--Asphalt can be used effectively in two ways to protect a hydraulic structure. It can (1) protect a soil embankment from erosion by

waves or stream currents, and (2) provide a porous layer to drain off groundwater seepage to prevent damage to the watertight lining from hydrostatic pressures.

Impermeable mixes--Linings of impermeable asphalt mixes consisting of well-graded aggregates provide an erosion-resistant, durable surface. Even when the waterproofing of an embankment is not required, impermeable asphalt revetments or facings resist scouring, weed growth, and other forms of potential physical damage.

Mastics--Asphalt mastics have been used extensively for surface linings in Europe, and have also been placed underwater to prevent scouring of the bottom of streams and inlets by water currents and tides. European engineers frequently use asphalt mastic seal coats to give added protection from abrasion to impermeable asphalt linings. Asphalt mastics provide a smooth surface that is highly resistant to the abrasive action of water, and also to mud or algae curl along the water line.

Porous Mixes--There are two types of porous mixes: permeable and open-graded. Permeable asphalt mixes are used to line reservoirs that are made watertight by compacted layers of earth. The asphalt linings protect the earth embankment from erosion and at the same time permit the free flow of water through the lining, thereby eliminating the danger of hydrostatic uplift pressures developing under the lining. Open-graded mixes are used to provide drainage layers beneath watertight linings. Drainage layers are designed to dispose of any seepage or leakage that may occur in the watertight lining. They are also used to drain away groundwater seepage that would otherwise build up hydrostatic uplift pressures underneath the watertight lining. Open-graded mixes, in addition to providing a subsurface drainage layer, add to the stability and overall strength of the lining.

Prefabricated Materials--Asphalt mattresses were developed in the United States principally for protecting stream banks from erosion. They have been used extensively in Europe and in Japan. Asphalt slabs have been developed for bank protection, and prefabricated asphalt panels may also be used for this purpose in certain situations.

2.05 ASPHALT FOR REINFORCING--

Mastic Mixes--Asphalt provides a means of reinforcing a stone structure or layer by binding the stones together to increase their resistance to displacement by water. A layer of stone such as riprap for bank protection frequently is grouted with an asphalt mastic mix. This binds the stone together, and is also used to level the surface of the stone layer.

Asphalt mastic mixes have also been effectively used as a grouting material in the construction and repair of stone jetties. Because the mixes retain heat even during underwater placement, the asphalt mastic flows into and fills cavities between the stones. Stone jetties grouted with asphalt mastics are monolithic structures that are much more resistant to the damaging forces of waves than ungrouted structures. Jetties grouted with asphalt also reduce or eliminate the flow of drift sand through the jetty itself, increasing its effectiveness in controlling sand migration.

Asphalt Cement--Grouting with asphalt cement is a simple and economical means of reinforcing riprap or stone layers covering an embankment. Construction procedures are similar to those followed in placing penetration macadam pavement courses for roadways. The method has seen more use in Europe than in the United States. Asphalt-penetrated, or grouted, stone covers on embankments are for bank protection; they are not intended as watertight linings. Although the asphalt or asphalt mastic fills many of the interstices, enough pores will remain to permit water to flow through the protective layer.

2.06 COMPOSITE USE OF ASPHALT

MATERIALS--A composite asphalt structure consists of layers of different types of asphalt mixes or materials with each layer or application performing a particular function. An example of a composite asphalt lining is an impermeable asphalt layer supported by an open-graded asphalt drainage layer with an asphalt mastic screeded over the compacted surface. In this case, the drainage layer serves to drain away any seepage through the lining or ground water to prevent damage to the watertight lining.

Composite layers of asphalt materials may also be employed to take advantage of economical local materials. An example of this form of composite construction is an asphalt revetment for a seawall where an

economical sand asphalt serves as a base and makes up most of the thickness of the structure. A proportionately thinner layer of high-quality asphalt concrete is then placed on the sand-asphalt base to resist the damaging erosive and abrasive action of ocean waves.

B. DESIGN CONSIDERATIONS

2.07 SUBGRADE PREPARATION--The subgrade is that portion of the sides and bottom of a canal, ditch, bank, reservoir, or pond upon which an asphalt lining is placed. Its preparation involves the same basic steps for all types of linings. The subgrade should be thoroughly cleaned of all organic and loose material. It should be compacted sufficiently to attain stability, particularly on side slopes, and to sustain loadings from the construction equipment used to place and compact the lining. It should be trimmed before, during, or after compaction as necessary, to make it smooth and uniform and to give the completed structure the required grade and cross-section. It is often advantageous to slightly under-excavate (or over-fill) so that there is some excess material for a final fine trimming after the subgrade has been compacted.

Certain soil conditions can contribute to extensive damage to asphalt linings. Ground water that cannot drain because of underlying impervious soil layers can exert sufficient hydrostatic uplift pressure to lift, crack or pop-out large sections of the lining. Where such conditions are likely to occur, preventive steps must be taken. The soil causing the problem should be removed to a depth of at least 0.3 m (1 ft) and replaced with a free-draining material. If this is not possible, pipe drains may be needed to place under the lining to intercept and drain away the ground water.

Subgrade soils that swell considerably when wet can exert pressure sufficient to damage asphalt linings. Inquiries should always be made regarding local experience with such soils. In general, they should be removed to a depth of at least 0.3 m (1 ft) and replaced with suitable material. In small structures, where removal and replacement of soil is not economically feasible, the subgrade should be compacted at a moisture content in excess of optimum in order to minimize adverse swelling pressures. Treatment of the subgrade soil with a small percentage of hydrated lime to control swelling may also be considered.

Cohesionless soils, such as sands of uniform grain size, present an unstable surface on which to place a lining, especially on side slopes. The surface of such a soil should first be stabilized with cutback or emulsified asphalt so as to provide a reasonably smooth, firm surface on which to place the asphalt lining.

2.08 WEED CONTROL--Weeds and other plants are a potential hazard to linings when certain favorable growth conditions exist. These conditions are: (1) subgrade contaminated with weed seeds or roots of perennial plants; (2) subgrade moisture conditions favorable to seed germination or root growth; and (3) subgrade temperature that favors growth for appreciable periods. Absence of any one of these conditions will prevent vegetation trouble but the simultaneous occurrence of all three will result in eruptions of growth through the average lining. When such conditions are anticipated, the use of a soil sterilant is advisable. The soil sterilant should not be a simple weed-killer but a compound that attacks roots and seeds and remains effective for an extended period. There are many commercial products that will accomplish these purposes. Most of them are either chemical compounds or petroleum derivatives. Where vegetation is present, the subgrade should be carefully grubbed before treatment.

In order to further protect against weed growth, proper rolling procedures for asphalt linings should be practiced. Small hairline cracks or fracture planes could develop from improper rolling or from rolling on a soft or spongy subgrade. These fissures provide lodging places for seeds, and upon germination, the roots may penetrate the lining to the underlying subgrade.

2.09 SLOPES--Generally, the steepest slope recommended for the successful placing and compacting of asphalt mixtures is about 1-1/2:1 (1-1/2 horizontal to 1 vertical). An asphalt lining on a sloped embankment does not act as a retaining wall. Instead, the embankment material supports the asphalt lining and the steepness of slope is dependent upon the slope stability of the foundation material.

Side slopes should be as flat as is consistent with other construction requirements for the satisfactory placing and compaction of the lining. Under certain conditions flatter side slopes can result in an overall saving in spite of the added expense of the embankment and increased area

of the lining, because of decreased construction difficulties.

The top and bottom edges as well as the ends of an asphalt facing or revetment must be designed in such fashion that they will not be damaged or displaced by wave action, stream currents, or surface water runoff. If the lining extends to the top of a sloped embankment, the paving should continue at least partially across the crest to prevent surface runoff from seeping into the subgrade immediately under the lining.

Asphalt paved linings or revetments that extend to the toe of the sloped embankment and to an unpaved floor should be designed to resist any creep stresses that may develop in the lining. If the floor of the structure is subject to scouring by waves, the anchoring of the lining should extend to a depth equal to twice the depth of the zone of scour.

If the slope paving joins a paved floor the toe of the embankment should be curved so that the paving machine can negotiate a smooth transition without the need of constructing a paving joint at the toe. This eliminates a possible weakness in the lining at one of its critical points. If the embankment toe cannot be curved, a wedge may be placed and compacted to ensure watertightness at the toe.

Where the top or bottom edges of the asphalt revetment extend neither to the crest nor to the toe of the embankment, they should be anchored into the embankment. This protects the edges from erosive forces that may displace the revetment by wave action or currents. It also prevents surface runoff from seeping into the embankment immediately underneath.

If the upstream end of an asphalt facing is exposed it should be heeled into the embankment to resist being displaced by water currents. Some suggested designs are shown in Figure II-2.

2.10 DRAINAGE--In some instances it will be necessary to provide a drainage system to prevent hydrostatic pressure from lifting an impermeable asphalt lining or revetment from an embankment. Such damage can occur in an asphalt-lined channel or reservoir whenever the water level drops below the surrounding groundwater table. An asphalt layer, unless it is porous and free draining, will be subject to displacement whenever the hydrostatic pressure under the lining exceeds the downward forces exerted on and by the lining.

If the soil is permeable, a system of drain pipes at the bottom of an asphalt-lined

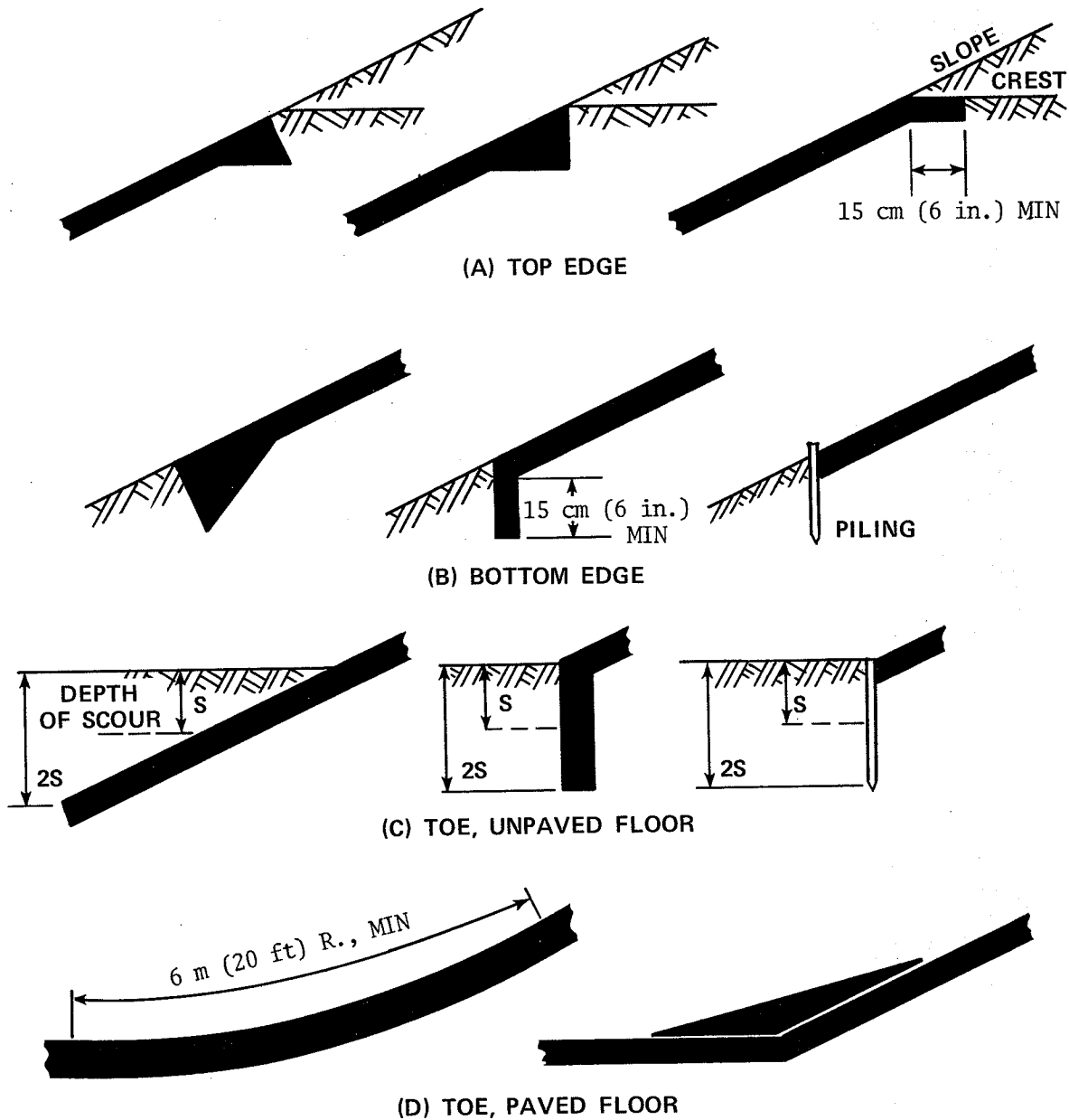

FIGURE II-2. Designs for top, bottom, and toe of asphalt paved linings and facings.

slope may be adequate. For less permeable soils, a drainage layer under the lining in addition to the drain pipes will be required. An open-graded asphalt drainage layer or a clean, free-draining granular layer may be constructed for this purpose. In either case, a good bond between the drainage layer and the impermeable lining, especially on the side slopes, must be ensured.

2.11 THICKNESS--Factors influencing the required thickness of an asphalt lining

for a hydraulic structure include:

- Impermeability
- Wave impact
- Stream velocity
- Uplift or cavitation.

Asphalt linings 5 cm (2 in.) thick having 4 percent or less voids will generally have a coefficient of permeability, k , less than 1×10^{-7} cm/s, which is considered to be impermeable to water. Paving joints, however, are often the least waterproof part of the lining. For this reason, most water-

proof linings are placed in two or more layers with the paving joints offset. Two 4 cm (1-1/2 in.) paved layers generally are accepted as the minimum thickness of an asphalt concrete lining for waterproofing a hydraulic structure. A properly-designed mix is both impermeable and flexible. It will conform to settlement of the supporting embankment resulting from long-term loadings without cracking.

In order to ensure a firm surface on which to place the lining, a leveling course is often recommended. The thickness of this course is usually limited to that necessary to support paving and compaction equipment. In addition to the courses making up the watertight lining, a final asphalt concrete surface course with offset paving joints is frequently placed. This is to further protect the paving joints in the underlying watertight course.

Asphalt linings on hydraulic structures such as seawalls or dikes must be strong enough to withstand the dynamic forces generated by breaking waves. Increasing the thickness of an asphalt lining increases its strength. A thickness of 20 to 61 cm (8 to 24 in.) may be necessary to resist damage by wave action on coastal structures. The asphalt lining may often be constructed with sand asphalt made from local materials in all but the top layers for economy of construction. For most reservoirs and bank revetments, a 7.5- to 10-cm (3- to 4-in.) asphalt lining in addition to the thickness of the leveling course will be sufficient to resist forces developed by wave action.

Water flow (especially at high velocities) in channels can result in localized low pressure areas in the flow. Uplift forces resulting from these low pressures can develop when there is a general disturbance of the stream flow, such as a hydraulic jump (an abrupt rise of water surface). Also, cavitation, which is generally caused by water flowing swiftly over an irregular surface, can result in uplift forces. Unless a lining is heavy enough to overcome these uplift forces, portions of it may be lifted from the subgrade. Linings for channels with velocities over 2.5 m/s (8 ft/sec) should be designed with this in mind. Linings 7.5 to 9 cm (3 to 3-1/2 in.) thick will usually be sufficient for water velocities up to 4 m/s (12 ft/sec). For greater velocities, the thickness should be at least 10 cm (4 in.).

2.12 ABRASION--An asphalt lining can suffer abrasion from sand, gravel, and other fine particles conveyed over its surface by moving water. A dense, fine-textured,

smooth-surfaced asphalt lining can withstand a great deal of abrasion without damage. Abrasion resistance can be attained through the use of quality materials and sound construction practices. In some instances where an asphalt lining will be subjected to unusual abrasion or scour, an asphalt mastic seal is included in the design to provide added protection for the surface of the lining. Such a mastic is commonly made up of asphalt and mineral filler with, perhaps, a small percentage of asbestos fibers. It is screeded on to the lining, and forms a smooth, dense surface.

2.13 COMPACTION--Adequate compaction of asphalt concrete linings is absolutely necessary if they are to be watertight and structurally sound. Unlike asphalt pavements for roads, the asphalt lining will not be further compacted under traffic after it is in service. Since the impermeability of an asphalt lining is dependent on the reduction of the voids in the mix below a certain value, it is most important to obtain the required density at the time of construction.

In many cases, rollers compacting asphalt mixes on slopes will have to be raised and lowered by cables attached to winching equipment at the top of the slope. The motors of the rollers should only be used to operate the power steering and vibrating units during the rolling operation. Rollers operating under their own power are likely to shove or ripple the pavement layer being compacted. Careful attention should be given to the rolling operation to ensure that transverse hairline cracks do not develop. These small fractures that form during improper rolling are not necessarily healed with succeeding passes of the roller. They result from the paving surface being overstressed by the roller. Hairline cracks not only increase the permeability of the lining, but decrease its durability, erosion resistance and structural integrity.

2.14 SURFACE PROTECTION--A layer of mud deposited on a pavement surface will shrink as it dries and curl like a leaf. This can also happen when algae or other sediments on a surface are allowed to dry. As these deposits shrink and curl, they can set up surprisingly large tensile stresses at the lining surface. A well-designed and compacted asphalt mix having a tightly bonded surface will be less susceptible to deterioration as a result of these stresses. In cases where surface protection is necessary, a cement wash has been found to be effective in preventing damage from curling. Sprayed asphalt cement seals are also sometimes used.



FIGURE III-1. Asphalt hot-mix being lowered to paver on Homestake Dam, Colorado.

CHAPTER III

TYPES OF ASPHALT APPLICATIONS

A. IMPERMEABLE ASPHALT CONCRETE LININGS

3.01 DESCRIPTION--Impermeable asphalt mixes are manufactured in central mixing plants where the aggregate, mineral filler, and asphalt cement are proportioned and mixed at a temperature of approximately 150°C (300°F). The mix is then hauled to the paving site where it is spread with either a mechanical spreader or by hand, and compacted while still hot. A low void content mix is required to ensure impermeability. Impermeable asphalt mixes are similar to asphalt mixes for highway paving except that they usually have higher mineral filler and asphalt-cement contents. Also a harder, or more viscous, grade of asphalt cement normally is used.

3.02 USES--The primary purpose of impermeable asphalt mixes is to waterproof hydraulic structures. Watertight linings are used to impound water in reservoirs, ponds, and lagoons; to waterproof dams, dikes, and embankments; and to prevent seepage losses in canals and channels. They are most often used as surface linings, since they are resistant to wave action and the erosive effects of water currents.

Revetments constructed with impermeable asphalt mixes are used for bank protection on streams, reservoirs, lakes, and shorelines. Waterproofing properties are not necessarily required in these instances, but quality asphalt concrete linings having low voids effectively resist the destructive effects of wave and current action as well as their abrasive effects.

Impermeable asphalt mixes may be used for the entire lining of the structure. They may also constitute a portion of a more complex lining. They can, for example, be placed as the surface of a composite section made up of different asphalt layers.

3.03 DESIGN CONSIDERATIONS--There are certain basic requirements for asphalt mixes to be used for waterproofing hydraulic structures. They must be workable while

placing, and impermeable, flexible, and stable in service. To ensure impermeability (k less than 1×10^{-7} cm/s) the void content of an asphalt concrete lining should not exceed 4 percent.

The lining will usually be placed on a sloped surface. Therefore, the mixture should be quite workable to allow efficient placement by both mechanical and hand methods. Normally, the desired compaction must be achieved using lighter compaction equipment, especially while operating on the slope.

The lining should be flexible. It must be able to withstand, without cracking, long-term loading stresses caused by settlements in the supporting subgrade or foundation. On the other hand, it must also be resilient under short-term loadings such as wave impact.

Increased asphalt content helps to satisfy the foregoing design requirements. However, after a certain point, an increase in asphalt content results in a decrease in stability. Although this mix need not have the high stability normally associated with highway paving mixes, it should be stable enough to support its own weight on relatively steep slopes while hot. Moreover, it should not creep after the lining has been compacted.

3.04 MIX DESIGN--Mix design of impermeable asphalt mixes for hydraulic structures follows the same general principles established for pavement mixes. Use of the Marshall Method of mix design is recommended. However, it is essential that the density of the compacted laboratory prepared specimens be comparable to that which can be obtained in the field. It is suggested that not more than 35 blows of the compaction hammer on each end of the specimen be applied, since the compaction effort on a slope is considerably lower than that possible on roadway pavements. European design engineers suggest that 5-to-15-blow specimens be prepared for mix design purposes. Other design considerations described in Article 3.03 should be noted.

The design procedure consists of selecting the grade of asphalt cement, choosing a suitable aggregate grading, preparing specimens at different asphalt contents, and making a density-voids analysis for each sample. The Marshall stability and flow value are used mostly for comparative purposes.

Research and experience have shown that in general, an AC-20 grade asphalt cement (or equivalent AR- or penetration grade, see Figure I-3) is preferred for hydraulic linings. This relatively viscous asphalt cement produces linings with added resistance to the destructive action of water, the growth of vegetation, and the extremes of weather. Linings made with this grade of asphalt cement are more stable on side slopes than linings made with the softer grades, yet they retain sufficient flexibility to conform to slight deformations of the subgrade.

The asphalt content will normally range from 6 to 9 percent, which is somewhat higher than the asphalt content of average roadway paving mixes. The asphalt content is limited, however, by the ability of the mix to resist flow down the slope at placement temperatures.

The aggregate used should be sound and have good adhesion characteristics in the presence of water. When the mix is to be placed on slopes steeper than 2-1/2:1, at least a portion of the coarse aggregate should be angular or crushed. The maximum aggregate particle size should be limited to one-third to two-fifths of the finished thickness of the paving course to ensure uniform density throughout the layer. For mineral filler, crushed limestone dust is generally preferred. However, other inert mineral dusts having satisfactory performance records may be considered. Suggested mix compositions for asphalt concrete for impermeable linings are listed in columns A, B and C of Table III-1.

As a final check, a test or trial strip is recommended. It should be placed under the same conditions as will be experienced in the field. Careful observation of the behavior of the designed mix during the spreading and compacting operation might indicate slight adjustments in the job-mix formula that could not be detected in the laboratory.

3.05 CONSTRUCTION--Hydraulic linings of asphalt concrete should be prepared and placed in accordance with established construction practices. However, some special aspects of construction are here mentioned.

Asphalt concrete linings are placed on side slopes, on curved sections, in angles and corners, and on level surfaces. This may be done by conventional highway spreaders, modified pavers or spreaders, spreader boxes, special slip-form pavers, hand methods, or some combination of these methods. In most instances, conventional highway spreaders are used. They are often modified as necessary for operating on a slope. Where side-slope paving and floor paving are separate operations, experience has shown that best results are obtained when the slopes of the reservoir or channel are paved before the floor.

Spreading on side slopes is usually performed by conventional highway spreaders winched up the slope; often they are modified to facilitate the work. In some cases, especially with large shallow reservoirs, asphalt mixes are spread with specially-designed finishers operating on rails within a steel frame structure up and down the slope. Also, side slopes of shallow reservoirs have been paved with the pavers moving along the slope longitudinally while held with cables attached to equipment operating on the crest. This method presents compaction problems, however, since rollers operating this way apply non-uniform rolling pressures and the drum tends to cut into the mix on the down-slope side.

When a spreader operates up and down the slope, a sloped ramp at the crest may be used to permit the paver to pave all the way to the top. Cable winches attached to the ramp framework raise and lower the paver on the slope. Upon completion of a paved strip with the paver on the ramp, the entire assembly is then moved over for the next paving pass.

There are several methods by which the paver may be supplied with hot mix for slope paving. Probably the most common one is to load the paver at the bottom of the slope with enough mix for one complete trip up the slope. Another method is to load the paver at the top of the slope and then lower it to the bottom for the paving pass. Where slope distances are too great for paving a strip without recharging, a front-end loader with a side-dump bucket has been used to supply the paver part way up the slope. Haul trucks can be winched down from the crest to provide additional mix to the paver. Cranes have also been successfully used to supply the paver on the slope.

Light steel-wheeled rollers and vibratory steel-wheeled rollers are often used for compacting the freshly-spread mix on the slope. Vibrating, heated ironing screeds

TABLE III-1

MIX COMPOSITIONS FOR FORMED-IN-PLACE ASPHALT LININGS

	A	B	C	D	E
Sieve Size	Percent Passing				
25.0 mm (1 in.)			100	100	100
19.0 mm (3/4 in.)		100	95-100	95-100	93-100
12.5 mm (1/2 in.)	100	95-100	----	85-95	----
9.5 mm (3/8 in.)	95-100	84-94	72-85	----	35-65
4.75 mm (No. 4)	70-84	63-79	53-72	44-56	5-25
2.36 mm (No. 8)	52-69	46-65	40-60	30-40	2-15
1.18 mm (No. 16)	38-56	34-53	30-49	----	0-7
600 μ m (No. 30)	27-44	25-42	22-39	13-22	0-3
300 μ m (No. 50)	19-33	17-32	16-30	----	----
150 μ m (No. 100)	13-24	12-23	11-22	3-8	----
75 μ m (No. 200)	8-15	8-15	8-15	1-4	----
Asphalt cement*, percent by wt. of total mix	6.5-9.5	6.5-9.0	6.0-8.5	5.0-6.0	2.0-4.0
Mix Type	Well-Graded (Low Voids)	Well-Graded (Low Voids)	Well-Graded (Low Voids)	Permeable (Medium Voids)	Open-Graded (High Voids)
Minimum Recommended Compacted Depth	4 cm (1-1/2 in.)	5 cm (2 in.)	6 cm (2-1/2 in.)	7.5 cm (3 in.)	7.5 cm (3 in.)
Recommended Usage	Impermeable Surface	Impermeable Surface	Impermeable Surface	Permeable Surface	Drainage Layer

*AC-20, or equivalent AR- or penetration grade, recommended (see Figure I-3).

(hand held, or incorporated in slip-form pavers) as well as rubber-tired rollers have also been used. Power winches and cables are usually required for maneuvering the roller up and down the slope. The rolling is done independently of the paving, but it should begin as soon as possible without interfering with the paver. The initial rolling pass is usually made up the slope. Depending on the stability of the mix, the vibrator may not be desired on the initial pass but rather on the following coverages.

When the lining is to be placed in two or more courses, the paving joints should be staggered or offset. Emphasis should be on

a tight bond for impermeability. Extra care should be taken with cold joints. The edge of the mat to be joined, should be sloped for the full depth of the layer and coated with liquid asphalt before the fresh asphalt mix is placed and compacted. It is important that the exposed mat edge have the proper slope; approximately 1:1. Too steep a slope will permit adequate compaction of the fresh mix, but allow a plane of weakness at the joint to develop. Too shallow a slope will result in the compaction equipment being supported by the coarse aggregate particles and bridging over some of the finer particles, preventing adequate compac-

tion of the mix at the joint. Ideally, the slope should be such that the mix will be "wedged" down and pressed securely against the face of the joint, getting proper compaction and bond at the interface. Infrared joint heaters can also aid in obtaining bond by preheating and softening the surface of the joint.

A tack coat is normally required whenever an asphalt mix is placed over another paved surface. For bonding impermeable asphalt layers together, a tack coat of SS-1, SS-1h, CSS-1, or CSS-1h emulsified asphalt diluted 1:1 with water and applied at a rate of 0.2 to 0.7 litre/m² (0.05 to 0.15 gal/yd²) over the surface to be paved will usually be adequate. Tack coats of emulsified asphalts should be allowed to cure fully prior to paving; otherwise moisture will be trapped between the two layers at the time of construction.

Tack coats can be critical when used to bond two impermeable layers together. An excessive tack coat application combined with warm temperatures can cause a slippage plane between two layers on a sloped surface. On the other hand, unless the two layers are bonded together so that there are no voids or pores in the interface, seepage water from a crack or opened joint may get between the layers. Should this happen, hydrostatic pressures can develop and eventually cause layer separation.

B. POROUS HOT-MIX ASPHALT LININGS

3.06 DESCRIPTION--Porous asphalt mixes for hydraulic structures are characterized by the absence or reduced amount of fine aggregate or sand in the mix. As a consequence, the asphalt content is also reduced. The mixes have interconnected pores that permit passage of water. A harder, or more viscous, grade of asphalt cement is desirable in these mixes to allow sufficient film thickness and to prevent drainage from the aggregate. This choice of asphalt also provides additional cohesion in the mix between the aggregate particles.

3.07 USES--There are two types of porous asphalt linings: permeable and open-graded. Permeable hot-mix asphalt linings serve as a cover over an earth embankment to protect it from erosion by wave action or surface runoff. Open-graded asphalt linings, with higher void content than the permeable lining, serve as drainage layers under an impermeable lining while at the same time contributing to the structural strength of the lining. In either case, the purpose is

to provide free drainage to prevent hydrostatic pressures from building up in the embankment or within the lining itself. As a surface lining, water is allowed to flow to and from the embankment through the lining. As a drainage layer, the subsurface water should be collected and carried off by drains.

3.08 MIX DESIGN--The principal purpose of preparing laboratory specimens for a proposed porous lining is to ensure that the mix to be used is indeed porous and will permit water to flow through the lining.

Typical mix compositions are shown in Table III-1, columns D and E. The mix shown in column D is primarily used as an exposed surface lining while the one in column E is used as a filter or drainage layer under a watertight lining. Asphalt cement AC-20, or equivalent AR- or penetration grade, is recommended in making up these mixes.

3.09 CONSTRUCTION--Essentially, the procedures for the placement of permeable surface lining mixes are the same as for impermeable asphalt mixes. However, they are generally placed in one layer 7.5 to 15 cm (3 to 6 in.) thick, rather than in two or more courses.

There is no real effort to obtain density in open-graded drainage layer courses; the intent is only to seat firmly the aggregate particles. Excessive rolling can be harmful by causing aggregate degradation or by breaking the asphalt bond between particles, particularly if the mix temperature is below 66°C (150°F).

With open-graded asphalt mixes such as mix composition E, the mix temperature should not exceed 121°C (250°F) at the plant. Temperatures higher than this may cause the asphalt to drain from the aggregate particles and settle in the bottom of the truck bed as it is hauled to the paving site. This problem is not normally encountered with mixes such as mix composition D.

C. ASPHALT MASTIC MIXES

3.10 DESCRIPTION--Asphalt mastic mixes for hydraulic structures are essentially mixtures of mineral aggregate and filler where the voids in the mineral matrix are overfilled with asphalt cement. The result is an asphalt mix that can be applied by pouring or by hand-floating into place. Asphalt mastics may be made from a variety of aggregate materials ranging from well-graded coarse and fine aggregates and mineral

filler to essentially mineral filler alone with or without an additive such as asbestos fibers. The mastic is voidless except for air bubbles that may be trapped during the manufacture and placing.

3.11 USES--Asphalt mastics can be used in several ways to waterproof, protect, or reinforce a hydraulic structure. For waterproofing, asphalt mastics have been used for cutoff walls for dams as well as for the central core of the dam itself. They are also used as exposed watertight surface linings.

Asphalt mastic mixes are erosion resistant. Therefore, they can be exposed to waves and abrasive water action. They are also used to form protective covers on embankments or over the floor of channels or estuaries that are subject to erosion. Hot mastic mixes can be placed underwater through tremies, chutes, or by simply dumping en masse. They are also used for constructing flexible slabs or mattresses that are lifted into place to form a protective blanket or cover.

For reinforcing, asphalt mastics are used as grouts to fill and plug the voids in stone structures such as jetties and riprap. The binding action of the mastic tends to make one firm mass. Yet mastics are flexible enough to conform to some differential settlement in the structure. Asphalt mastics are also used as joint fillers to bind stone blocks together on coastal structures, particularly in European construction.

3.12 DESIGN CONSIDERATIONS--The viscous properties of the asphalt mastic under service conditions will probably be the principal design consideration. However, the viscosity of the mix during placement is also important. The purpose for which the asphalt mastic is to be used and the manner of placement will require certain minimum and maximum viscosities. In most instances the mastic must be pourable and its viscosity low enough during application to permit sufficient penetration into the void spaces it is expected to occupy. On the other hand, the viscosity of the mastic during service conditions must be high enough to keep long-term flow within acceptable limits. These requirements will depend upon temperatures, slope angle, and the size of void spaces or cavities to be filled.

3.13 MIX DESIGN--For most purposes, asphalt mastics consist of sand, mineral filler and asphalt cement. The composition of the mixes can vary within wide limits, so

it is possible to make extensive use of local materials. A typical sand-asphalt mastic has the following composition:

Sand	60-80 percent
Mineral filler	10-20 percent
Asphalt cement	10-20 percent

The filler to asphalt ratio (by weight) should generally be at least two to three. In some instances, coarse aggregate is added to give the mastic mix more "body" or to increase the stability for certain applications or uses. As much as one part coarse aggregate (stone chips or screenings) to two parts sand-asphalt mastic can generally be used and still produce an essentially voidless mix. Sand-asphalt mastics with added coarse aggregate have been used for linings, precast slabs and mattresses, and for grouting stone jetties.

A paper by R. E. Kerkhoven* presented at the 1965 meeting of The Association of Asphalt Paving Technologists (AAPT) described how sand-asphalt mastics might be designed on the basis of viscosity. A correlation was established between the solid phase, V_{sf} , (ratio of compacted volume of the sand-filler blend to the total voidless volume of the mastic) and the viscosity ratio (viscosity of the mastic mix divided by the viscosity of the asphalt) at the same temperature. Details of this procedure are in Mr. Kerkhoven's paper.

There are no firmly established viscosity limits for either placement or service conditions. There will be different viscosity requirements for varying applications and service conditions. However, for grouting work the viscosity of the mastic should be between 10 and 10^3 Pa·s (10^2 and 10^4 poises) at the time of placing and 10^8 and 10^{11} Pa·s (10^9 and 10^{12} poises) under service conditions.

Asphalt cement AC-10 or AC-20 (or equivalent AR- or penetration grade, see Figure I-3) may be used, depending on the required properties at placement and service temperatures. For underwater applications it may be desirable to use even softer grades of asphalt cement so that they can be placed at lower temperatures, thus reducing the formation of steam.

Mastic asphalts for surface seals consist essentially of mineral filler and

* Kerkhoven, R. E., "Recent Developments in Asphalt Techniques for Hydraulic Applications in The Netherlands," in Proceedings, Volume 34, Association of Asphalt Paving Technologists' Annual Meeting 1965.

asphalt. They are described in the following section on surface treatments.

3.14 CONSTRUCTION--Asphalt mastic mixes can normally be prepared in batch-type hot-mix plants, provided that the pugmill is in good condition, and equipped with tight-fitting gates. Care must be exercised in hauling the mastic to the job site, especially if the mix is fluid or the haul distance is great, to prevent the sand and larger aggregate particles from settling to the bottom of the mix. In Europe, where mastic asphalts are used extensively, special mixing plants are used as well as special containers with stirring paddles for transporting the mix.

In most instances, the mastic is poured and floated, trowled, or worked into place. It can be deposited by chute or tube for more rapid placement. For underwater placement, the mastic should be confined in a mass as much as possible to the point where it is dumped. This may be accomplished using tremies or similar devices or even dumping en masse if placed in shallow depths. Usually the mix holds enough heat to flow into place before it cools.

D. SURFACE TREATMENTS

3.15 PURPOSES--A surface treatment may be applied to an asphalt surface for a number of reasons. It may be designed to make the surface more watertight, or to protect it from abrasion by waves, water currents, or even by ice. It may also be used to protect the surface from mud curl or the curling of drying algae along the waterline, to give the surface a lighter color in order to reduce temperature extremes, or to reduce the rate of oxidation of the exposed asphalt surface.

3.16 SPRAYED ASPHALT SEALS--Asphalt cement or emulsified asphalt sprayed over the surface of an asphalt lining at the rate of 1 litre/m² (0.25 gal/yd²) will provide a film coating as much as 1 mm (0.04 in.) thick. A continuous film coating will fill and seal any exposed pores and increase the watertightness of the asphalt lining. It will also tend to fill and seal small cracks in the surface that may have been caused by improper rolling procedures in compacting the lining.

The surface should be clean, dry, and free from loose material. Its temperature should preferably exceed 38°C (100°F). A sloped surface usually necessitates hand spraying. This should be done in a back-

and-forth sweeping motion to build up the film and to keep the asphalt from flowing down the slope.

3.17 ASPHALT MASTIC SEALS--In addition to providing a seal, asphalt mastics applied to the surfaces of asphalt linings provide extra surface protection from mechanical abuse. Asphalt mastics permit a heavier coating than sprayed applications, and well-designed mixtures can make the surface resistant to abrasion by waves, or scouring by waterborne sands.

Asphalt mastic mixtures for this purpose are essentially blends of mineral filler and asphalt cement. A small percentage (about 2 percent) of asbestos fibers is sometimes added to the mix to increase stability. The composition of the mastic for sealing can vary widely. However, it should normally fall within these ranges:

Mineral filler	50-70 percent
Asphalt cement	30-50 percent

Such mixes require squeegeeing, and they produce a smooth finished surface. Depending on the consistency of the mix, the surface thickness will be 3 mm (1/8 in.) or less. Fine sand may be added to give a gritty surface texture. When this is done, asphalt contents below 30 percent may be desirable.

These mixes usually are too liquid to prepare in a conventional hot-mix plant; special mixing equipment may be necessary.

AC-20 asphalt cement (or equivalent AR- or penetration grade, see Figure I-3) is normally used, but lower viscosity grades are also employed.

3.18 NON-ASPHALT SURFACE TREATMENTS-- Sometimes it is desirable to add a surface treatment to an asphalt lining even when sealing the surface is not required. Surface treatments of this nature protect the surface from possible damage by mud curling or drying algae at the waterline and lighten the color to reflect the sun's rays. One treatment that has been used extensively with satisfactory performance is a cement wash. The solution consists of:

Portland cement	1 sack (42.6 kg or 94 lb)
Calcium chloride	4.5 kg (10 lb)
Water	38-60 litres (10-16 gal)

The wash should be applied as thinly as possible. The spreading technique should provide uniform coverage, yet the dark surface

of the asphalt should plainly show through the freshly-applied wash. The surface should be wet before application. The application rate depends upon the surface texture. A "one-sack" mixture will cover 60 m² (72 yd²) or more of a porous or rough-textured surface, and approximately 90 m² (108 yd²) of smoother surfaces.

E. BURIED ASPHALT MEMBRANE

3.19 DESCRIPTION--An asphalt membrane (hot-sprayed type) consists of a continuous layer of asphalt usually without filler or reinforcing of any kind. It is covered or buried, to prevent the surface from weathering and also to protect it from physical damage. The membrane may be one of the lower layers of a multi-layer or composite lining, but more often it is simply covered with native soil or gravel. Membranes are usually about 6 mm (1/4 in.) thick and provide a continuous, waterproof layer. Asphalt, air-refined to achieve special characteristics, is used to make these membranes into tough, pliable sheets that readily conform to changes or irregularities in the subgrade. Buried under a protective cover, an asphalt membrane will retain its tough, flexible qualities indefinitely. It is the least expensive type of lining, yet it has waterproofing capabilities equal to any.

3.20 USES--Buried asphalt membrane construction was developed by the U. S. Bureau of Reclamation in cooperation with the asphalt industry to provide an efficient, low-cost means of controlling seepage in earth-lined irrigation canals and laterals. Some of these linings are in satisfactory condition after more than 20 years of service.

Since the first installation on a lateral in Oregon in 1947, many canals and laterals have been lined with the sprayed asphalt membrane, and its uses have expanded to include waterproofing shallow reservoirs and small dams. The ability of the asphalt to withstand reasonable concentrations of acids and many chemical-laden waters makes the buried asphalt membrane an effective waterproof lining to prevent the pollution of ground water by sewage lagoons, sanitary landfills, and waste treatment ponds. It has also been used effectively to waterproof basins for the chemical leaching of ores from mining excavations.

3.21 DESIGN CONSIDERATIONS--In most cases the sprayed asphalt membrane will be

buried; therefore the structure to be lined should either be over-excavated or the depth of cover considered in designing for impounded depths or channel capacities. Where native soil is used, a minimum thickness of 30 cm (12 in.) is recommended. However, for large canals and reservoirs, as much as 1 m (3 ft) of cover has been used. Graded sands and gravel are the most suitable soil covers; plastic or expansive soils are the least desirable.

The permissible velocity in a membrane-lined channel is usually somewhat less than in an unlined channel constructed in similar soil. This is because soil covers are generally placed without the benefit of maximum consolidation and in this state, scour can be a hazard to the membrane. When water velocities in the channel exceed 0.5 m/s (1.5 ft/sec), where wave action or turbulence exists, or where livestock may enter or cross, it is advisable to face the cover with 7.5 to 15 cm (3 to 6 in.) of pit-run or crusher-run aggregate. A cover of asphalt penetration macadam has also been used for this protective purpose.

The cross section of the channel should be carefully designed. Although the asphalt can be satisfactorily applied on steep side slopes, the stability of the supporting subgrade and the membrane cover material limits the slope angle. The design should also consider the effects of a rapid draw-down of the water level, as this may cause the sloughing of some earth covers.

The surface to be lined should be smooth so that the resultant membrane will be continuous, of uniform thickness, and free of holidays caused by protruding stones. In some cases it may be necessary to dress the subgrade surface with a fine-grained soil to choke relatively large surface voids and provide a uniform surface texture. Such a surface also reduces the amount of asphalt required to build up the desired membrane thickness.

High softening point asphalt should be used for buried membrane construction. This is necessary in order to prevent sagging or flow down a slope should the cover material be accidentally removed, exposing the membrane to the sun's rays. It should also be plastic enough at service temperatures to minimize the danger of rupturing from earth movements. A blown asphalt having the properties listed in Table III-2 is recommended.

3.22 CONSTRUCTION--The three basic steps in the construction of buried asphalt membrane linings are subgrade surface pre-

TABLE III-2
 REQUIREMENTS FOR ASPHALT FOR USE IN WATERPROOF CONSTRUCTION
 Membrane Construction
 (ASTM D 2521)

Softening point (ring and ball),	79° to 93°C (175° to 200°F)
Penetration of original sample:	
At 25°C (77°F), 100 g, 5 s	50 to 60
At 0°C (32°F), 200 g, 60 s	30 min
At 46°C (115°F), 50 g, 5 s	120 max
Ductility at 25°C (77°F) cm	3.5 min
Flash Point (Cleveland open cup)	218°C (425°F) min
Solubility in carbon tetrachloride, %	97.0 min
Loss on heating, %	1.0 max
Penetration at 25°C (77°F) after loss on heating, % of original	60 min

paration, application of asphalt membrane, and placement of the cover material. After rough excavation the surface should be smoothed and dragged to remove sharp angles in the surface made by the excavation equipment. If the subgrade consists of rough, irregular rock, open gravels or similar, a fine sand or soil padding is placed for membrane support. The surface is then rolled with a light roller. The object of these preparations is to achieve a smooth surface so that a reasonably uniform membrane is obtained without using excessive asphalt.

Owing to the characteristics of the very hot asphalt, dust bubbles and pinholes tend to form when it is sprayed over a dusty subgrade. A very light sprinkling of water over the subgrade just prior to spraying the asphalt will reduce the dust problem. It is important that the asphalt membrane be applied in at least two successive applications in order that pinholes that may form in the first application be sealed off.

The recommended spray application temperature of the asphalt is 200°C to 220°C (392°F to 428°F). The asphalt should not be overheated because by this the softening point could be lowered, and the characteristics of the material changed. Hand sprays or spray bars fitted with slot-type nozzles should be used to apply the asphalt under a pressure of about 345 kPa (50 lb/in²). Unless the surface to be sprayed is very firm, the distributor should not travel over the area being sprayed; instead, it should move alongside and be equipped with offset spray bars.

The handling of high-softening-point asphalts requires skill and planning to prevent "freezing" in the hose lines or spray bars. Hose lines for hand applica-

tions should be insulated, and application should be as continuous as possible. Spray bars should not be shut off for more than 1 to 2 minutes at a time, and all pipes, pump lines, and bars should be cleaned with air or distillate immediately after spraying operations are completed.

The asphalt should be applied at a rate of 7 litres/m² (1.5 gal/yd²) to obtain a membrane 6 mm (1/4 in.) thick and to ensure impermeability. As mentioned, multiple passes are preferred in building up the membrane thickness. Three passes, applying asphalt at about 2.3 litres/m² (0.5 gal/yd²) yields a desirable "ply" effect. The nozzles of the spray bar should be kept at least 15 cm (6 in.) but not more than 45 cm (18 in.) above the surface being sprayed. The asphalt is applied in essentially one operation. Since the high-softening-point asphalt chills rapidly, successive applications can be applied almost immediately. The asphalt cools quickly, and in a few minutes the surface can be walked on for inspection or any corrective action. However, equipment should be kept off the membrane to prevent rupture or other damage.

The cover material should be stockpiled nearby. It is generally placed by casting from drag lines. However, many methods for placing the material using other standard equipment can be devised. It is important that equipment be kept off the membrane until an adequate thickness of cover has been placed. Material should not be bulldozed over a berm and down the slope, as the membrane may be damaged by sliding soil or rolling stones. If the cover contains stones that might puncture the membrane, a layer of fine sandy soil should first be placed over

the membrane. Normally, compaction of the cover will not be necessary, but smooth-faced steel rollers may be used if required. Dragging the surface of the soil cover will smooth the surface and improve the appearance of the completed work. Care in the construction and maintenance of the membrane cover will add much to the serviceability and longevity of the completed structure.

F. PREFABRICATED ASPHALT PANELS

3.23 DESCRIPTION--The typical prefabricated asphalt panel consists of a core of ductile, blown asphalt fortified with mineral fillers and reinforcing fibers. The ingredients are blended and molded under heat and pressure. The core is then sandwiched between protective sheets and a protective coating of hot-applied asphalt cement. The protective sheets may be an asphalt-impregnated felt, or plasticized or flexible glass fabrics.

Asphalt panels are usually about 13 mm (1/2 in.) thick, but they are available as thin as 3 mm (1/8 in.) thick. They are usually 1.0 to 1.2 m (3 or 4 ft) wide and 3 to 6 m (10 to 20 ft) long for handling and placing. Asphalt panels are flexible and can be fitted to bend and conform to junctures of the side slope and floor of a hydraulic structure. Properly supported, they are tough enough to be used as an exposed surface lining and can withstand erosive and abrasive water forces, and support light vehicles.

3.24 USES--The most extensive use of prefabricated asphalt panels has been in lining and waterproofing all types of water storage reservoirs, including domestic water reservoirs, sewage lagoons, industrial waste-treatment reservoirs, evaporation ponds, and reflecting pools. They are also used for lining canals and ditches, and for bank protection. Asphalt panels have the advantage of providing a relatively thin watertight barrier that can be used as a surface lining. In addition, they do not require heavy machinery to install. They are useful for relining reservoirs where the concrete lining has cracked badly and where leaking has been excessive. Prefabricated asphalt panel linings are also used as an element of composite lining structures, most frequently serving as the watertight surface of a built-up lining.

Like hot-mix asphalt linings, prefabricated panels import neither odor nor taste, nor do they discolor the water. Ground

squirrels and other rodents usually find them impossible to penetrate.

3.25 DESIGN CONSIDERATIONS--Prefabricated asphalt panels will bend and conform to the surfaces on which they are laid, and will withstand high water pressures. They should not be bent or rolled so sharply that the protective sheet or layer will overstretch or break. Ordinarily, they should not be bent in a curve having a radius of less than 30 cm (12 in.). The lining may be anchored at the top of the slope by tucking the edge of the lining into the subgrade, anchoring it with special spikes and backfilling with at least 15 cm (6 in.) of cover. Larger reservoirs may have coping walls, paved walks or roadways around the top, with column footings or other protuberances within the structure. The panels should be securely bonded using an asphalt primer followed by an asphalt adhesive.

Manufacturers of asphalt panels usually have personnel qualified both to design panel linings and to supervise their installation. For the most part, the considerations for designing a structure for hot-mix asphalt linings are applicable to preparing it for prefabricated asphalt panel linings.

Once the asphalt panels are in place, the initial filling of the reservoir should not exceed 1 m (3 ft) of depth per day. Limiting the filling rate is necessary to enable the lining to assume its final shape slowly without overstressing the joints.

3.26 CONSTRUCTION--Procedures for installing prefabricated asphalt panel linings are relatively simple, but they require careful planning and workmanship. Scale drawings should be prepared in detail to show how all pieces are to be fitted together and joined.

The subgrade is prepared as for other types of asphalt linings. The structure is excavated or filled to grade, then smoothed, rolled and treated with a soil sterilant if required.

The panels should not be abused in handling or they may be damaged. When stacking panels, an insulating material such as mica flakes should be sprinkled over their surfaces to prevent them from bonding together.

The panels are laid parallel and closely butted or lapped. They are then bonded securely with either specially prepared hot or cold asphalt mastic adhesives. Cold adhesives do not require heating equipment at the job site, but do require more time for construction and bonding. In either

case, the bonding surface must be clean and dry.

Sealing the joints is the critical operation: they must be tightly and permanently bonded. Panels may be either butted, with overlay strips cemented over the joint, or they may be lapped and cemented together.

G. MISCELLANEOUS

3.27 SAND ASPHALT--Sand asphalt is a mixture of sand, with or without added mineral filler, and asphalt cement. Mineral filler added to the mix permits a higher asphalt content and makes it possible to obtain a denser, tougher, and more stable mix.

Sand asphalt has been used alone for linings, as base courses for other linings, for revetments, and for groins. The largest use of sand asphalt for hydraulics purposes in the United States probably has been for bank paving along the Mississippi River by the U. S. Army Corps of Engineers. The Netherlands has made extensive use of sand asphalt in the construction of sea-wall revetments. Typically, the base thicknesses range up to 20 cm (8 in.) and are usually capped with a layer of asphalt concrete.

Local sand deposits generally can be used since gradation is not particularly critical. The asphalt cement should be AC-20 (or equivalent AR- or penetration grade) or a higher viscosity grade. A typical mix would have an asphalt content of about 6 percent. If about 5 percent mineral filler is added, the asphalt content would probably be around 8 percent.

Sand-asphalt mixes for linings are not as watertight as specially-designed hydraulic asphalt concrete. However, laboratory testing with different mineral filler and asphalt contents can usually produce an essentially voidless but workable mix. The established general principles and procedures of laboratory mix design for hydraulic structures are the same as those for roadway pavement construction.

Hot-sand asphalt is prepared and placed in much the same way as other asphalt hot mixes. It is very workable while hot, affording the possibility of using hand methods for placing and shaping. On the other hand, it may be difficult to operate heavy compaction equipment on freshly-placed material until it has been allowed to cool.

3.28 ASPHALT PRIME TREATMENTS--Priming the soil surface of a hydraulic structure with asphalt is often done to seal it temporarily or to reduce seepage until such

time as waterborne sediments in the impounded water settle and plug the soil pores. Asphalt primes have also been applied to sloped embankments before placing a sprayed-asphalt membrane. The purpose, in this case, is to anchor the membrane to the slope. Primes have also been used for much the same purpose as prime treatments of roadway surfaces prior to paving operations; that is to plug up voids and to provide a more stable surface on which to place asphalt construction.

Prime treatments are neither watertight nor permanent. They are most applicable to silty-sand soils that are quite permeable. Appropriate asphalts for this type of treatment are MC-30, or sometimes MC-70 or RC-70 cutback asphalts.

Application rates depend upon the character of the soil. Nominal penetration by the asphalt is desired; free asphalt on the surface or flowing down the slope is not. The treatment should be allowed to cure before impoundment or before further construction proceeds.

3.29 WATERBORNE ASPHALT SEALANTS--Waterborne asphalt sealants have been used to reduce excess leakage in unlined canals and ponds. The method of treatment is simply to pour emulsified asphalt into the water. The asphalt sinks to the bottom and as natural percolation takes place, the asphalt particles clog the pores at or near the soil surface. Treatment can be done in flowing water but best results are obtained in standing water. A slow-setting cationic emulsified asphalt is usually preferred for this treatment. The amount required will depend on the porosity of the soil; but an application rate of 2.7 to 3.2 litres/m² (0.6 to 0.7 gal/yd²) of earth surface generally will suffice. For better coverage, the asphalt should be poured into the water from several places at the same time as the facility is being filled. The agitation of the water helps to distribute the asphalt. This work can be carried out as part of normal maintenance, but the treatment should be repeated every three or four years. Chances are, the application rate can be lower for later treatments.

3.30 ASPHALT INJECTION--Asphalt injection is the subsurface application of asphalt pumped under pressure through pipes. The method is used to reduce leakage of a hydraulic structure through underground cracks, fissures, and cavities.

A blown asphalt such as that used for buried asphalt membrane construction or for

undersealing is generally used. Emulsified asphalt with filler material has also been successful. It also is possible to use relatively low-viscosity sand-asphalt mastics for this purpose.

The hot, fluid asphalt is usually pumped through heated perforated pipes dropped into drilled holes at the leakage strata levels. Once in the leakage channel, the asphalt spreads out and hardens into a tight plug or water stop. With sufficient pumping pressure, the asphalt will do this even in fissures filled with water. These asphalt plugs can adapt to slight movements in the formation and changes in water pressure.

3.31 ASPHALT UNDERSEAL--Asphalt undersealing provides an economical means of salvaging old, deteriorating portland cement concrete linings. The hot asphalt, pumped into voids beneath the old linings, spreads out under the slab and fills the cavities, forming a leak-proof plug. The technique is similar to undersealing highway and airfield pavements; the materials also are similar. Asphalts used for undersealing conventional pavements or those used for buried asphalt membrane construction should be employed.

Preparation of the old surface for undersealing generally consists of drilling holes through the surface. The holes should be about 4 cm (1-1/2 in.) in diameter. There should be one hole for each 8 m² (10 yd²) of pavement to be undersealed. The holes should be cleaned with compressed air. Hot asphalt is pumped through the hand hose of an asphalt distributor to the injection gun. The nozzle is about 30 cm (12 in.) long and has a gasket to seal the hole against leakage during application. The asphalt is pumped under pressure, usually 100 kPa (15 lb/in.²), until the required amount has been injected. Next, the holes are plugged with wooden plugs that are removed after the asphalt has cooled. The holes are then filled with an asphalt paving mixture, thoroughly tamped in place.

Caution is necessary if there are buried drain-pipes nearby, since the asphalt may fill them during the injection process.

3.32 ASPHALT-COATED MATS--Asphalt-coated mats consist basically of felt or fabric sheets installed and coated with asphalt to form a watertight lining or membrane. They were originally used on earth slopes around highway bridge abutments as protection against erosion caused by water runoff. They have since been used for waterproofing bridge decks, roofs, and even for seal-coat patches

on road pavements. In hydraulic installations, they line or seal reservoirs, lagoons, ponds, small ditches and canals. Asphalt mats have also been used to seal existing lined structures that have deteriorated and are no longer waterproof. The mats can serve permanently or as a temporary protective covering. Recent developments in the manufacture of fiberglass felts and mats as well as plastic and polymer fabrics have also made this form of lining or membrane construction attractive.

The method of installation will vary in detail but essentially it consists of placing and anchoring the mat to the surface to be covered, then spraying or mopping the mat with asphalt. The mat and asphalt film form a watertight membrane. Sometimes sand or stone chips are spread over the surface to protect the asphalt coating and to reduce surface temperature.

3.33 ASPHALT MATTRESSES--Asphalt mattresses are precast sections or blankets of asphalt mastic reinforced with wire mesh and steel cables or fiber netting and lines. Generally they vary in thickness from 25 to 50 mm (1 to 2 in.). Their length and width are limited only by the size of the molding platform and the capabilities of the equipment used to manipulate and place them.

The reinforced asphalt mattress was developed by the U. S. Army Corps of Engineers in 1932-34 for use on underwater revetments on the banks of the lower Mississippi River. Continuous asphalt mattresses were cast on a special barge pulled into the water. Mattresses have since been adapted for use in European hydraulic structures and in Japan. Their principal function is to protect the surface on which they rest from erosion or scour by waves and currents. They are often used at the toe of a revetment or lining. After a short period, the edge of the mattress settles into the scour zone, thus stabilizing the erosive process. Asphalt mattresses are also used as linings and as protective blankets for hydraulic structures.

The asphalt mastic used in these mattresses usually is a relatively viscous mixture of graded aggregate, up to 9.5 mm (3/8 in.) in size, mineral filler, and AC-20 (or more viscous) asphalt cement (or equivalent AR- or penetration grade). The reinforcing makes it possible to move the mattress from its molding platform to its place of installation. The mesh or netting also helps keep the mattress intact as it flexes and settles into place.

PART II:

EXAMPLES OF APPLICATIONS

Note: Grades and types of asphalt mentioned in the examples were current designations at the time of construction.

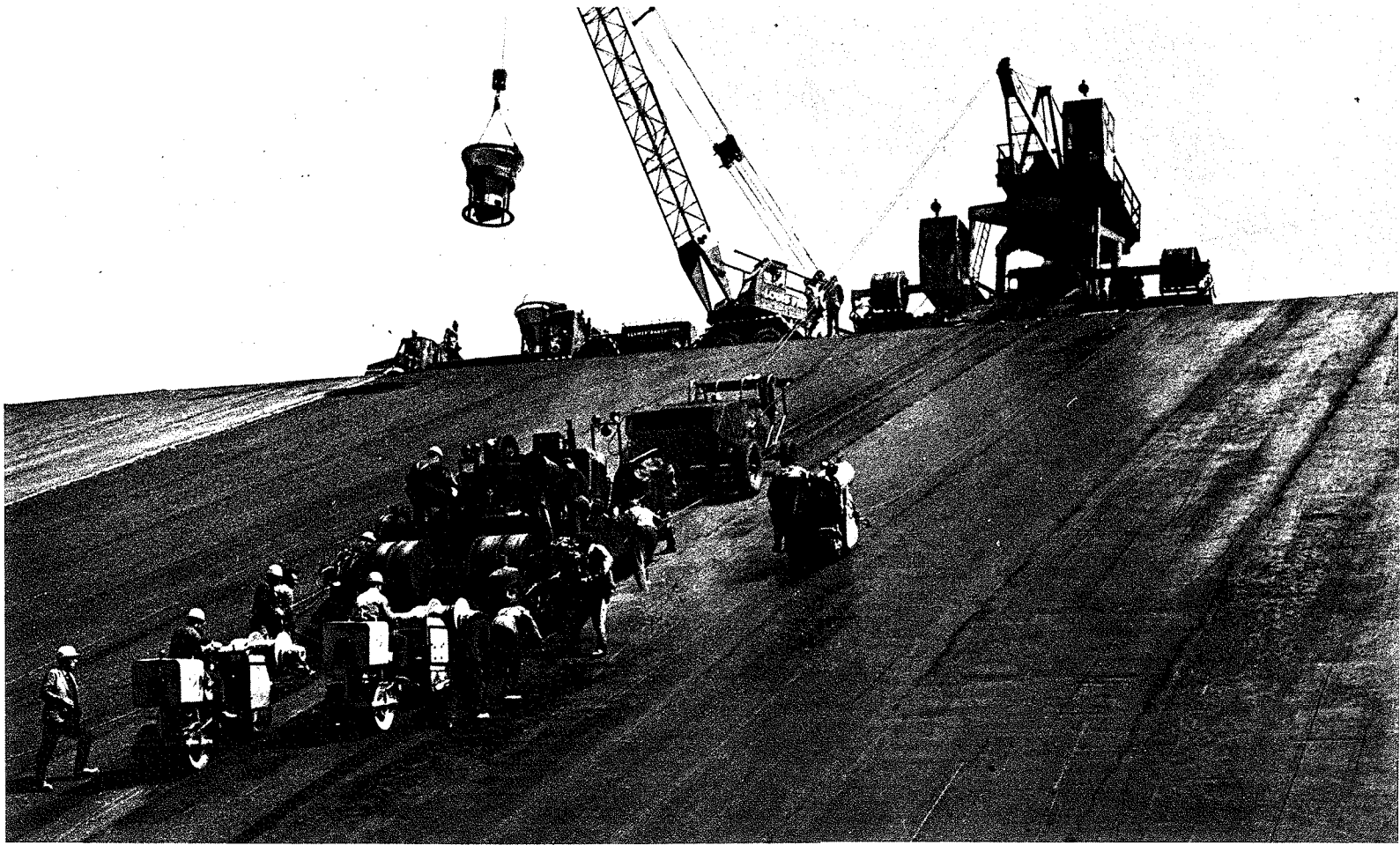

FIGURE IV-1. (Above) Construction of asphalt concrete lining on Innerste Dam, Germany; (photo courtesy Shell International Petroleum Company, Ltd.).

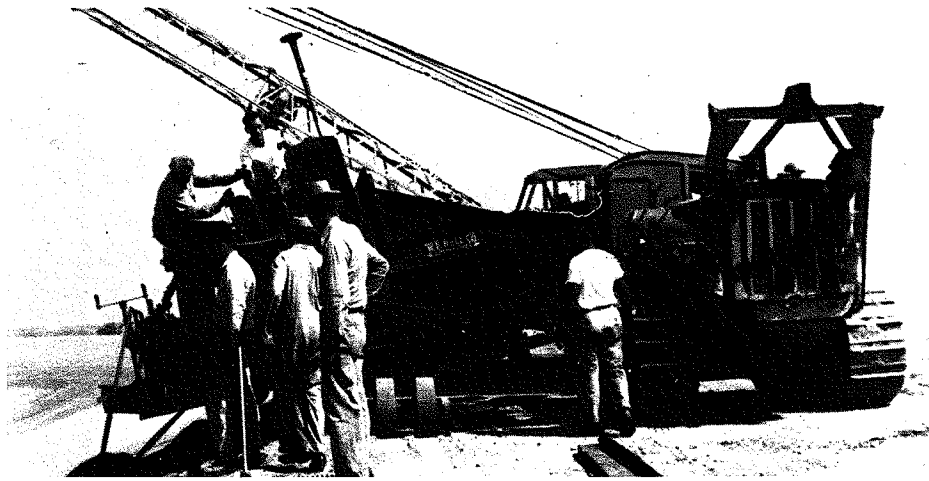

FIGURE IV-2. (Left) Asphalt paving machine hoisted on special ramp for repositioning, Garvey Reservoir, California.

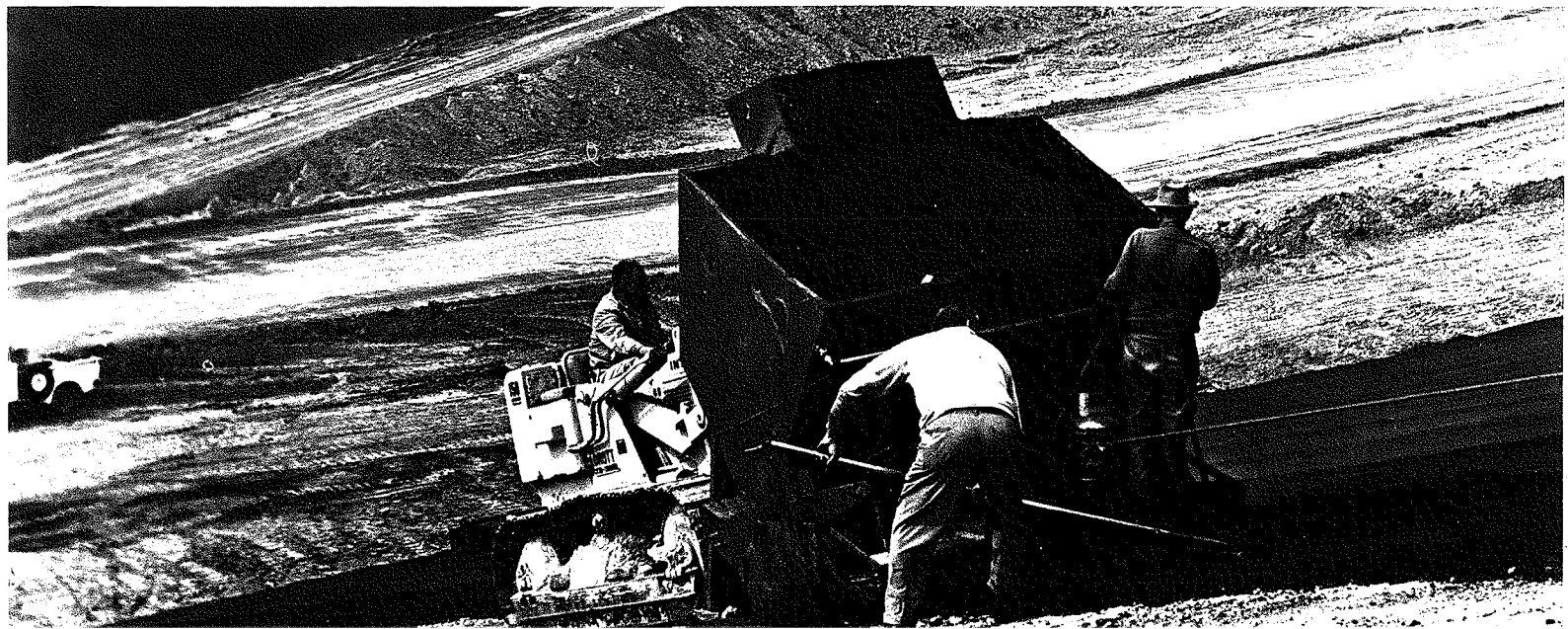

FIGURE IV-3. (Below) Spreader box mounted on arms of front-end loader, San Joaquin Reservoir, California.

CHAPTER IV

ASPHALT IN RESERVOIRS AND DAMS

A. ASPHALT LININGS FOR RESERVOIRS

4.01 GENERAL--The use of asphalt to line or waterproof man-made water reservoirs has been established and developed during the past 40 years. The large area-to-depth ratio of reservoirs makes practical the use of standard asphalt paving machines and other conventional paving equipment in their construction. On the slopes, cables from winches stationed at the top are required for controlling and maneuvering the equipment. A combination of standard paver, dump truck, and steel-wheeled tandem roller, each cable-controlled and maneuvered, has frequently been used to pave reservoir slopes as steep as 2:1 with 3:1 slopes being the most common. On some smaller reservoirs, and in portions of large reservoirs where use of machinery proves difficult, placing, spreading or compacting the mix is done by hand. In general, standard asphalt paving procedures are followed when paving the floors of reservoirs.

4.02 SOUTHERN CALIFORNIA--In Southern California there are several filtered-water reservoirs that are essentially earth-lined structures faced with a 7.5-cm (3-in.) permeable asphalt lining. This is particularly true of a number of reservoirs owned or operated by the Metropolitan Water District of Southern California and the Los Angeles Department of Water and Power. The permeable asphalt mix consists of crushed aggregate (see Table III-1, column D for gradings) and asphalt cement, usually 60-70 penetration grade. Such a mix generally provides 17 to 22 percent voids after compaction. The permeable mix allows water to flow through the lining to relieve hydrostatic pressure under the lining during drawdowns of the water level in the reservoir thus preventing uplift of the facing. The asphalt facing simply prevents the erosion of the waterproofing earth blanket and provides a hard surface for vehicles during cleaning and maintenance operations. Typically, the surface of the asphalt facing is given a

thin sprayed-on cement wash surface coating as described in Article 3.18 to protect it from tensile forces resulting from drying and shrinking clay, silt, and algae. The side slopes of these reservoirs range from 3:1 to 2:1.

A variety of methods, a few of which are described here, have been developed for placing and compacting the asphalt lining.

The first use of conventional asphalt paving equipment for lining the side slopes of a reservoir was in 1954 on the Garvey Reservoir, in Monterey Park near downtown Los Angeles. A sloped moveable ramp, Figure IV-2, was positioned at the top of the embankment and was used for hoisting the asphalt finishing machine. After placing a strip of pavement by being pulled up the slope, the paver was hoisted up onto the ramp to complete the last several feet of paving at the crest. The ramp was then repositioned for the next paving pass. The operation required the use of three hoists located on the crest of the reservoir embankment--one for lowering dump trucks to deliver fresh asphalt mix to the paver, one for pulling the paving machine up the slope, and another for the 4.1-tonne (4-1/2-ton) roller for compacting the mix. For areas on the slope inaccessible to the paving machine and the roller, the material was spread by hand and compacted by a small hand roller.

More recently, the San Joaquin Reservoir, located 32 km (20 miles) southeast of Los Angeles, was faced with a 7.5-cm (3-in.) permeable asphalt lining in 1965 by a specially built spreader. The spreader box, shown in Figure IV-3, was mounted on the arms of a front-end crawler-type tractor loader. The spreader box was modified by adding a 8.2-tonne (9-ton) capacity tilting hopper for operating on the 3:1 to 2:1 side slopes. The screed platform was also altered to allow the screed-men to ride at a comfortable angle while paving on the slope. To ensure proper lining thickness, the tracks of the spreader were replaced with steel skids mounted at the proper angle. This also stabilized the spreader and permitted

full control of the spreading operation. The asphalt mix was placed as the unit was lowered down the slope by cable. A crawler-type front-end loader equipped with a side-discharge bucket traveled on the slope under its own power to supply asphalt mix to the spreader. Compaction was accomplished by removing the front drum from a tandem roller and raising and lowering it from the top of the slope with a winch attached to a truck. The roller weighed just over 0.9 tonne (1 ton). Compaction was obtained in three to four passes.

4.03 EAST BAY MUNICIPAL UTILITY DISTRICT --Beginning with completion of Seneca Reservoir in 1950, the East Bay Municipal Utility District (EBMUD), Oakland, California, lined a number of domestic water supply reservoirs with asphalt materials. One of the earlier designs was a four-layer lining. It consisted of a watertight sprayed-asphalt membrane over a 2.5-cm (1-in.) dense, asphalt-concrete layer, placed on a 7.5-cm (3-in.) open-graded asphalt layer. A 10-cm (4-in.) reinforced portland cement concrete lining formed the surface of the composite structure, as show in Figure IV-4.

As more reservoirs were built, most of which were roofed, the lining design evolved to essentially that shown in Figure IV-5. A 7.5-cm (3-in.) open-graded asphalt drainage layer permits drainage of any subgrade water to the lowest point, where it is carried off by the drains. This open-graded mix is described in Table III-1, column E. Upon this layer a 2.5-cm (1-in.) course of impermeable asphalt concrete is placed. This forms the base for the surface layer of 13 mm (1/2 in.) thick prefabricated asphalt panels. The asphalt paneling extends over a portion of the column and wall footings to maintain a watertight seal. The multi-layer lining is designed to prevent seepage of water into the subgrade and to relieve any hydrostatic pressures that may build up underneath the lining.

A good example of the use of asphalt panels to reline a reservoir is the 23,000-m³ (6-million gal) San Pablo Clear Water Reservoir. This covered reservoir had a badly-leaking rigid lining. It was relined without removal of the cover by applying 13-mm (1/2-in.) prefabricated asphalt panels and cold-applied asphalt mastic joint sealer. All material was brought in through small access doors. The relining effectively controlled leakage and has given excellent service.

4.04 ONONDAGA COUNTY WATER DISTRICT--
The Eastern Reservoir, 5 km (3 miles) east

of Syracuse, New York, is the first of a series of reservoirs built by the Onondaga County Water District for water storage. Constructed in 1964, the 110,000-m³ (30-million gal) reservoir is 91 m (300 ft) wide, 163 m (535 ft) long, and 11 m (36 ft) deep. It is completely lined with an impermeable asphalt concrete lining 15 cm (6 in.) thick. A bank-run gravel blanket 107 cm (42 in.) thick on the side slopes and 45 cm (18 in.) thick on the floor supports the asphalt lining as shown in Figure IV-6. Underneath the gravel layer on the floor of the reservoir is a 6-mm (1/4-in.) sprayed-asphalt membrane covered by a 15-cm (6-in.) layer of concrete sand. A 4.5-m (15-ft) radius transition curve joins the sloped embankment to the floor of the reservoir. A longitudinal drain system is installed in the foundation soil at the toe of the embankment. In addition, a 1.5-m (5-ft) dike divides the reservoir so that it need not be completely emptied should repairs be necessary.

Specifications for the asphalt concrete were similar to requirements for the asphalt concrete used to face the Montgomery Dam in Colorado (see Article 4.08), except that 8 to 8-1/2 percent asphalt cement, 60-70 penetration grade, was specified. The asphalt for the sprayed membrane was a 50-60 penetration grade asphalt cement used for filling joints and cracks on New York highways. The surface of the compacted gravel drainage layer was primed with MC-70 cutback asphalt prior to placement of hot mix.

A conventional paving machine was lowered by cable from a winch attached to a crane located on top of the embankment (see Figure IV-7). The asphalt concrete lining was laid in two 7.5-cm (3-in.) lifts. The mix was delivered and deposited in a steel hopper located at the base of the embankment. A rubber-tired front-end loader moved up the sloped embankment under its own power to deliver the hot mix to the paving machine. To ensure watertightness, the joints of the 2.4-m (8-ft) wide paving strips of the top layer were offset 1.2 m (4 ft) from the joints of the lower layer. The outer edges of the paving strips were tapered over a 30-cm (12-in.) width for the full depth of the layer. The beveled face was coated with emulsified asphalt prior to placing the adjoining strip.

While the paving machine placed a strip down the slope, a 1.4-tonne (1-1/2-ton) vibratory roller, raised and lowered on the slope by a tractor, compacted the previously-paved strip. A 9.1-tonne (10-ton) tandem roller was used in addition to the smaller roller for final compaction of the top course.

FIGURE IV-4. Simplified typical cross-section of reservoir lining used in earlier construction, EBMUD, California.

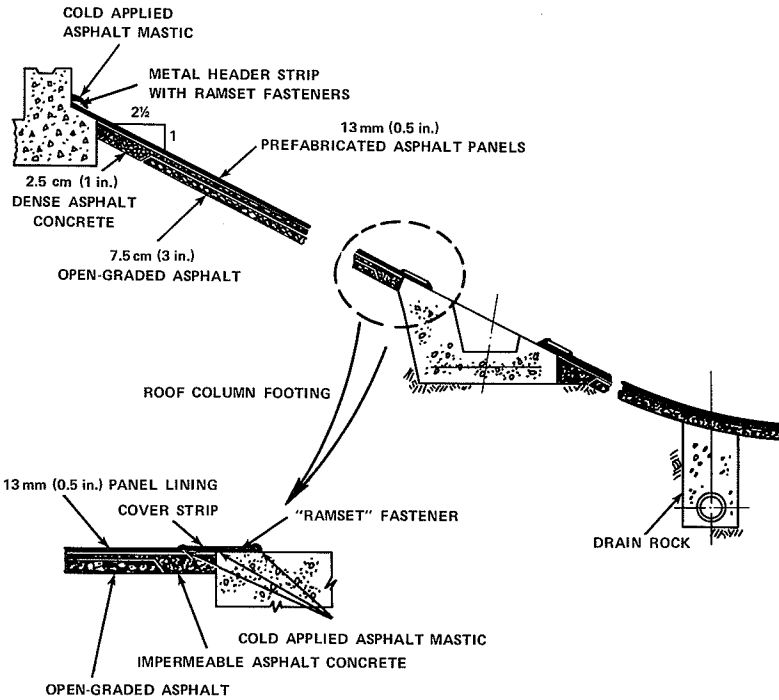
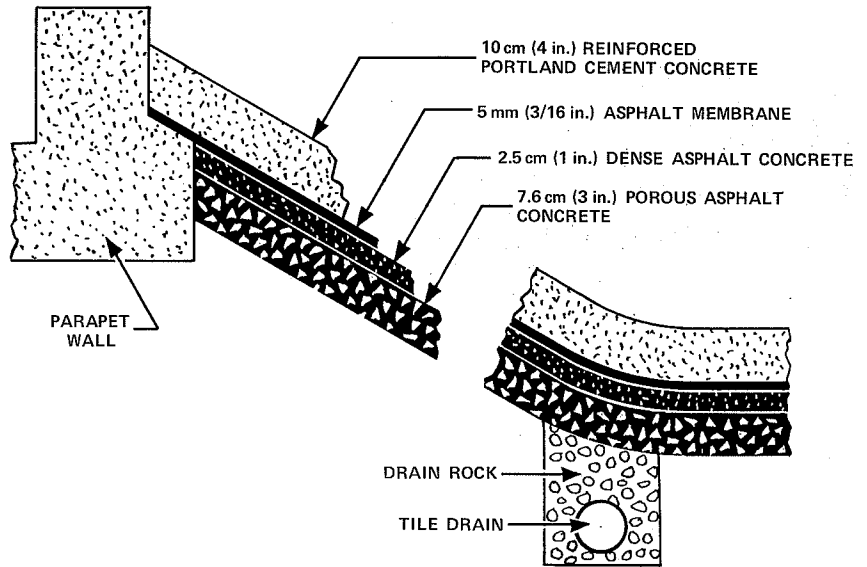
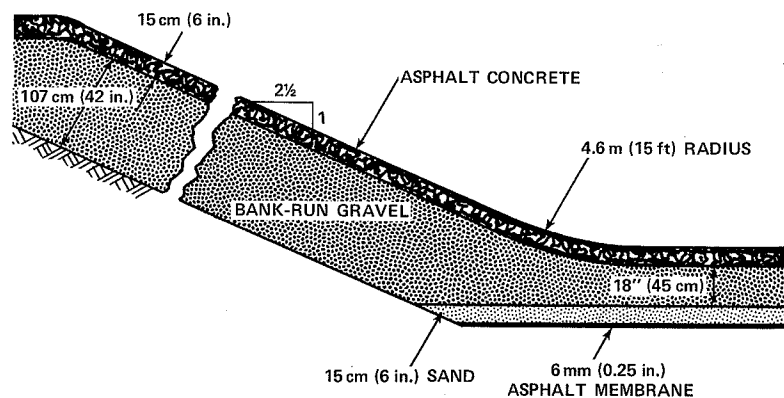

FIGURE IV-5. Typical cross-section of reservoir lining developed by EBMUD, California.

FIGURE IV-6. Cross-section of asphalt lining, Eastern Reservoir, Onondaga County, New York.



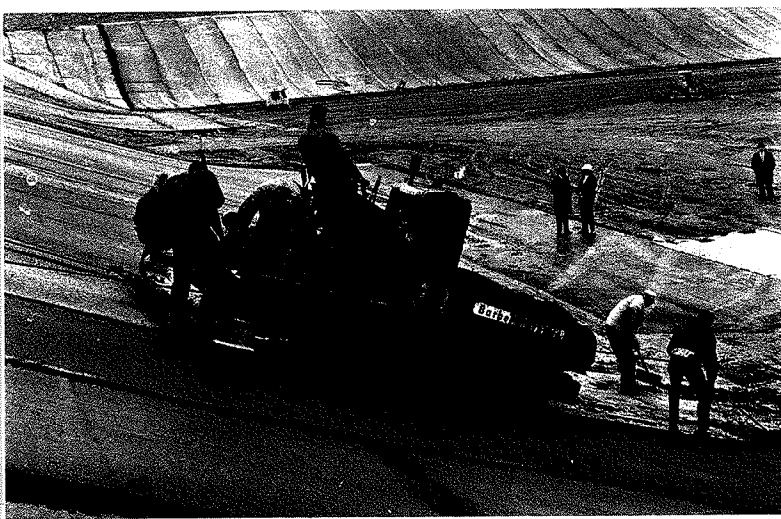

FIGURE IV-7. Asphalt paving machine spreading asphalt mix, Eastern Reservoir, Onondaga County, New York.

Paving down the slope presented a few problems. Occasionally, whenever excessive sand was encountered in the granular base layer, the loader supplying mix to the paving machine on the slope spun its wheels and had to be pushed by a crawler-type tractor. Also, since the asphalt mix was quite rich, it was necessary to keep the mix temperature below 155°C (310°F) to prevent the material from flowing down the slope behind the paver.

The performance of the lining has been most satisfactory. A second reservoir west of Syracuse and yet another near Rochester, incorporate the same basic design for both the lining and the asphalt concrete mix used to waterproof the structures.

4.05 UPPER RESERVOIR, SENECA POWER PROJECT--The upper storage reservoir of the Seneca Power project, jointly owned by the Cleveland Electric Illuminating Co. and the Pennsylvania Electric Co., is located near the Kinzua Dam near Warren, Pennsylvania. The completely asphalt-lined circular reservoir is nearly 0.8 km (1/2 mile) in diameter. It is 21 m (70 ft) deep, with the sides sloped 2:1. Paving began late in 1967 and was completed in September 1968.

The asphalt lining on the sloped sides consists of a 7.5-cm (3-in.) impermeable asphalt concrete lining placed in two lifts. This waterproofing layer was placed on a 7.5-cm (3-in.) open-graded asphalt drainage layer which in turn rested on a varying thickness sand-gravel base. An asphalt mastic was squeegeed over the surface at about 2.7 kg/m² (5 lb/yd²) to further seal the lining. A cross-section of the lining is shown in Figure IV-8. The waterproofing layer of asphalt and the sand-gravel base continue over the floor of the reservoir, but the asphalt drainage layer ends at the bottom of the slope. A 12-m (40-ft) verti-

cal curve provides the transition from the floor of the reservoir to the sloped sides. A perforated drainage pipe in a filter bed was installed underneath the lining around the perimeter of the floor.

The impermeable asphalt mix was composed of crushed sand and gravel with limestone mineral filler added and graded as shown in Table III-1, column A, with 8 percent asphalt cement, 60-70 penetration. The asphalt drainage layer mix consisted of crushed stone graded as in Table III-1, column D, with an asphalt content of 2 percent. The asphalt mastic had the following composition:

	Specification	Typical
Percent Mineral Filler	50-60	52
Percent Asbestos	2	2
Percent Asphalt, 50-60 pen	40-50	46

Prior to paving operations, the entire area to be paved was treated with a weed killer.

4.06 LUDINGTON PUMPED-STORAGE PROJECT--When completed in 1973, the Ludington, Michigan, pumped-storage reservoir became the world's largest structure of its kind. It also represented the most extensive use of asphalt in a single hydraulics structure. The reservoir, approximately 3.5 km (2.2 miles) long, and 1.6 km (1 mile) wide, is located along the eastern shore, and 105 m (344 ft) above Lake Michigan, which serves as the lower reservoir. The 1 x 10⁸ m³ (82,000 acre-ft) capacity reservoir is formed by a 9.7-km (6-mile) long embankment averaging 31.4 m (103 ft) in height. The inner slope of the embankment is waterproofed by two impermeable layers of asphalt concrete with a granular drainage layer sandwiched in between. A cross section of the inner slope and asphalt lining is shown in Figure IV-9 and IV-10.

The calcareous silty-sand subgrade was first primed with a special cutback asphalt to protect it from wind and rainfall erosion until it could be paved. A 7.5-cm (3-in.) impermeable layer of asphalt concrete was then placed and compacted in one course. A blown asphalt was sprayed over the compacted surface to form a membrane seal that extended 15 m (50 ft) up the slope. On top of this a 46-cm (18-in.) crushed-stone drainage layer was placed and compacted. Within the drainage layer, a 25-cm (10-in.) slotted fiberglass pipe located near the base of the slope extends the full length of the embankment. At 46-m (150-ft) intervals, 20-cm (8-in.)

FIGURE IV-8.
Cross-section
of reservoir
lining, Upper
Reservoir,
Seneca Power
Project,
Pennsylvania.

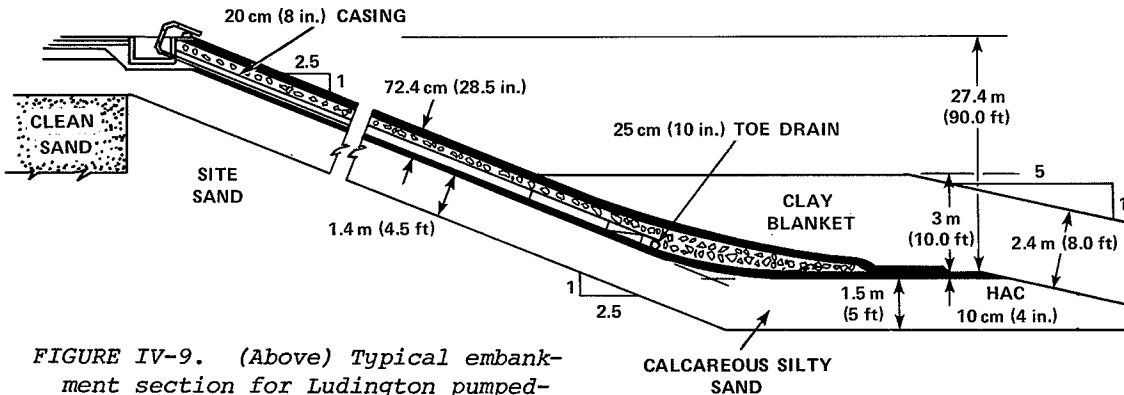
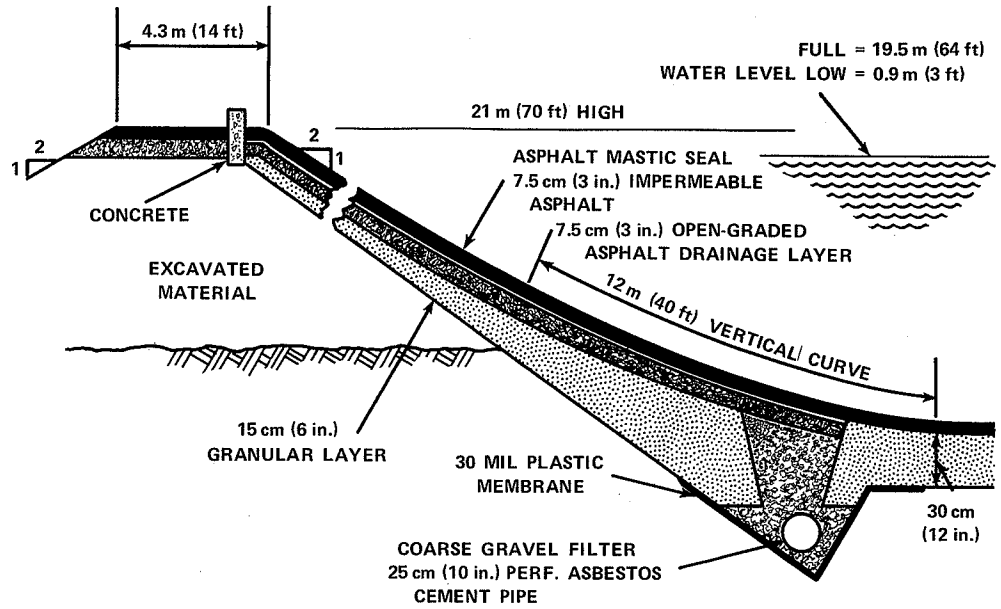

FIGURE IV-9. (Above) Typical embankment section for Ludington pumped-storage reservoir, Michigan.

CROSS SECTION OF 72.4cm (28.5 in.) WATERTIGHT LINING

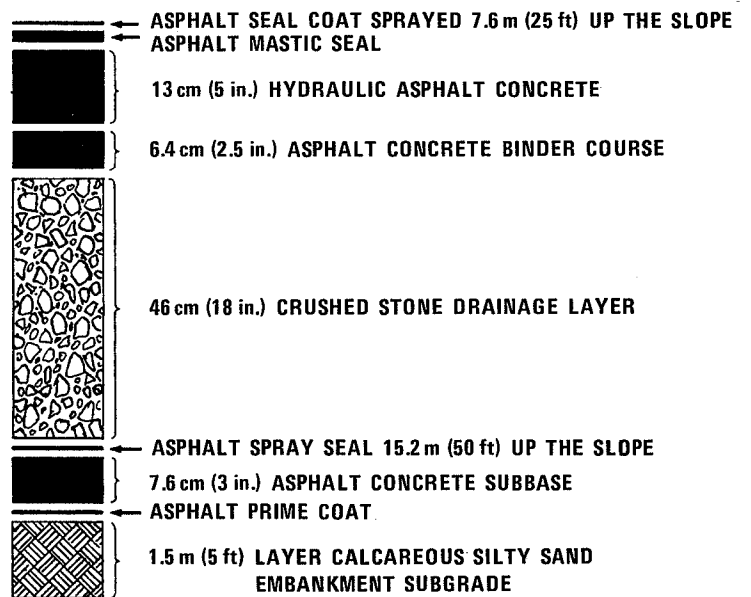

FIGURE IV-10. Typical cross-section of the watertight lining, Ludington pumped-storage reservoir, Michigan.

casings, equipped with sump pumps, connect to this drainpipe and run up the slope and out the top of the lining at the crest. Any water that might seep into the drainage layer is thus collected and pumped out from within the lining.

A 6.5-cm (2-1/2-in.) asphalt concrete binder course was then placed and compacted on top of the drainage layer. This was followed by two courses of an impermeable asphalt concrete to form a 13-cm (5-in.) thick watertight layer. Then an asphalt mastic seal was squeegeed over the entire surface. Additionally, a special cutback asphalt seal coat was applied to the portion of the lining surface that would support the 3-m (10-ft) clay blanket.

The impermeable asphalt concrete (referred to as hydraulic asphalt concrete) layers had an average void content of 2.7 percent and a Marshall stability of 5560 N (1250 lb) with a flow of 32, based on 35-blow specimens. The asphalt mix was a blend of siliceous aggregates [retained on the 4.75-mm (No. 4) sieve], crushed limestone mill sand, and crushed limestone mineral filler. The asphalt content was 6.75 percent by total weight of mix using 60-70 penetration grade asphalt cement. The grading limits, as well as the job-mix limits for the aggregate are as follows:

U.S. Sieve Size	Percent Passing by Weight	
	Specification Limits	Job-Mix Formula Limits
19.0 mm (3/4 in.)	100	100
12.5 mm (1/2 in.)	80-100	90-98
9.5 mm (3/8 in.)	72-95	85-93
4.75 mm (No. 4)	48-68	60-68
2.36 mm (No. 8)	34-54	44-50
1.18 mm (No. 16)	24-42	28-34
600 μm (No. 30)	16-32	18-24
300 μm (No. 50)	10-24	14-20
150 μm (No. 100)	7-18	12-18
75 μm (No. 200)	5-15	11-14

The embankment forming the dike was built up from material excavated from within the reservoir area. This was typically a fine sand. A 1.4-m (4-1/2-ft) layer of calcareous silty sand, also locally available, covered the inner face of the embankment and served as the subgrade upon which the asphalt lining was placed.

The paving contract was awarded late in 1970 to an American and a West German contractors operating in joint venture. The

paving was completed in 1972. Four special "bridge" units were designed and built especially for paving the inner slopes of the reservoir. They operated in pairs. One fo the units paved the lower half of the sloped embankment, the other the upper half, as shown in Figure IV-11. These special pavers were used for all paving courses except for the final 6.5-cm (2-1/2-in.) course. For this layer, modified conventional pavers were used to provide continuous strips of hot-mix asphalt from toe to crest. Other conventional pavers were used for other pavement courses to maintain a high production rate.

All pavers, including the special bridge paving units, were fitted with vibrating, gas-heated screeds. In addition, a gas-heated, vibrating plate compactor was towed behind each paving unit to impart extra compaction along the paving joint as the screed advanced up the slope.

The bridge paving units were fitted with skip hoppers that would provide the screed unit with enough hot mix to make a complete paving pass halfway up the slope. The hopper of the upper unit was loaded from trucks at the crest of the slope, while the hopper of the lower unit was loaded at the base of the slope. The conventional pavers were provided mix from special hopper-buggies lowered from the crest by the same winching rig used for raising and lowering the asphalt pavers.

Small 4.1-tonne (4-1/2-ton) vibratory rollers, usually raised and lowered by winches on the paving units themselves, provided initial compaction to the hot mix. Heavier 9.1-tonne (10-ton) vibratory rollers gave the additional compaction required. They were raised and lowered by special winching rigs located at the embankment crest.

Special attention was given to the paving joints in the top 6.5-cm (2-1/2-in.) layer. A rig consisting of an infra-red heater and gas-heated vibratory plate compactor (Figure IV-12) was pulled up the slope to reheat and recompact the joint.

The asphalt mastic used to seal the surface course was a blend of 62 percent mineral filler, 3 percent asbestos fibers, and 35 percent asphalt cement. It was applied by a special squeegee rig that spread the hot mastic as it was pulled up the slope by winching equipment mounted on the crest. A clay blanket 1.5 m (5 ft) thick covers the floor of the reservoir. At the base of the embankment there is a zone between the toe of the asphalt lining and the floor of the reservoir where the clay blanket is 2.4 m (8 ft) thick and lies on a

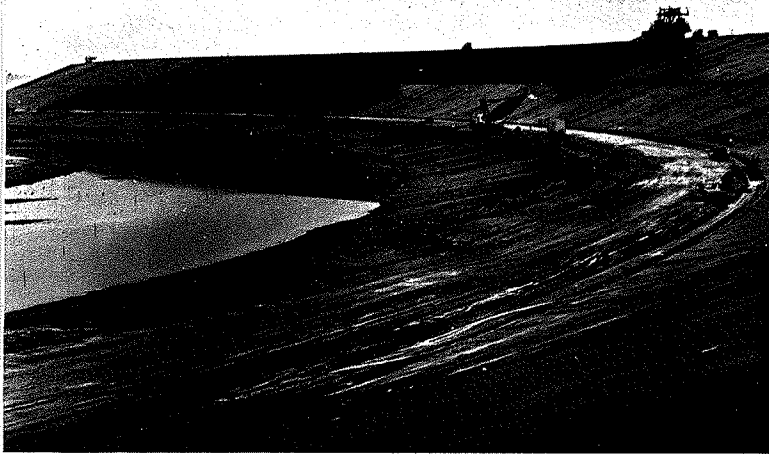

FIGURE IV-11. A pair of specially designed and built paving units placing the initial paving course, Ludington pumped-storage reservoir, Michigan.

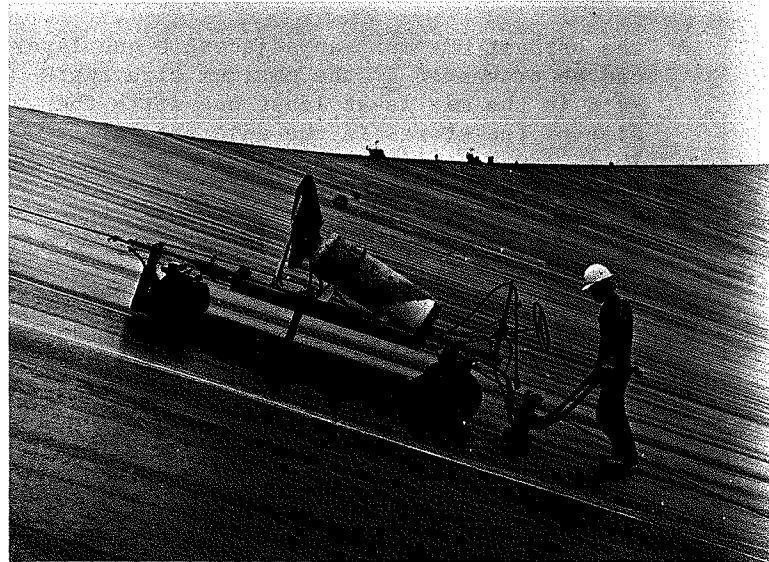

FIGURE IV-12. Workman recompacting paving joint, Ludington pumped-storage reservoir, Michigan.

5:1 slope. Where the blanket overlaps the asphalt lining, it is 3 m (10 ft) thick. The compacted lining will be under at least 1.5 m (5 ft) of water at all times. At full reservoir, the water level will be 2.4 m (8 ft) below the crest. An asphalt paved roadway, essentially an extension of the asphalt paving on the slope, is located on the 6.4 m (21 ft) wide crest.

B. ASPHALT IN DAM CONSTRUCTION

4.07 GENERAL--The first examples of the use of asphalt for dams go back to about 1935. The asphalt revetment of the El Ghrib Dam in Algeria, constructed in 1937, was one of the first large-scale applications. Since then, some 80 dams have been built or are under construction using asphalt to protect and seal them.

Earth and rockfill dams can be sealed either with an impermeable lining on the upstream face, or a vertical or a sloped internal core (Figure IV-13). Most of the earth and rockfill dams have been constructed using asphalt as a watertight lining on the upstream face. However, particularly in Europe, an increasing number of dams are being built with internal cores, especially in earthquake areas or at sites where large settlements are expected. Additionally, asphalt cutoff walls are constructed in the abutment sections of dams to stop underflow, or flanking flow, through pervious soil strata, channels, or fissures. Although the use of asphalt for dams and reservoirs is now well established, the work still requires careful control and supervision.

Skilled labor and workmanship are essential, as is some specialized or modified equipment. An asphalt mix at the base of a high dam must resist being forced into the underlying stone layer under the sustained high pressure head. Tests have shown that penetration of

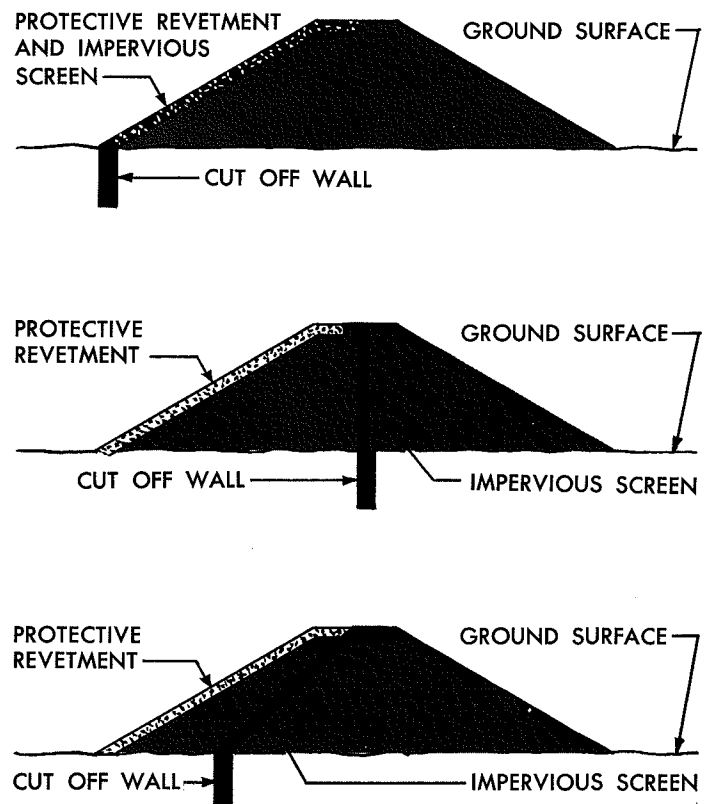

FIGURE IV-13. Alternate asphalt courses for dams.

the asphalt mix into an adjacent stone layer can be prevented if the maximum size aggregate in the mix is at least one-sixth the size of the stones in the adjacent layer. In a German publication, a value as small as one-eighth is mentioned.

4.08 MONTGOMERY DAM--The Montgomery Dam is a coreless rockfill structure with a watertight asphalt concrete facing. This facing covers completely the upstream slope of the structure and, at the toe, hooks over and bonds to a concrete cutoff wall forming an impermeable barrier across the valley.

The dam is located on the middle fork of the South Platte River, high in the Rocky Mountains of Colorado, at an elevation of approximately 3,350 m (11,000 ft). It is 34 m (113 ft) above the lowest point of the stream bed and has a crest length of 580 m (1900 ft). The rockfill is granite, quarried from the mountainside. The downstream slope of the structure is 1.4:1; the upstream face is 1.7:1. To allow for expected settlement, the crest of the dam was cambered (over-filled) 0.9 m (3 ft) at the maximum section, sloping uniformly to zero at each abutment. Construction of the dam began in August 1954 and was completed in 1957, when the asphalt paving was placed.

The design, combining rockfill with an asphalt concrete facing, was selected for a number of reasons, most important of which was economy. The cost was less than for any other equivalent design. Further, in an area where the construction season is very short, the method saved perhaps a year of time. The asphalt facing was placed in less than two months.

The design mix finally selected was:

Sieve Size	Percent Passing	
	Grading Limits	Design Mix (Washed)
38.1 mm (1-1/2 in.)	100	100
19.0 mm (3/4 in.)	80-95	86.8
12.7 mm (1/2 in.)	71-89	76.5
4.75 mm (No. 4)	55-75	58.7
2.0 mm (No. 10)	40-60	46.5
425 µm (No. 40)	22-36	30.0
180 µm (No. 80)	14-26	19.2
75 µm (No. 200)	7-15	12.8

50-60 penetration grade asphalt cement 8.5 percent
± 0.2 percent by weight of aggregate.

Three types of rock or zones comprise the dam structure. The interior bulk of the dam

is composed of large, mostly 0.45 to 4.5-tonne (0.5 to 5-ton) rock. The second zone is a 3-m (10-ft) layer, measured horizontally, of intermediate-sized rock with no particles smaller than 7.5 cm (3 in.). The surface on which the asphalt paving was placed was a layer of 19 to 75-mm (3/4 to 3-in.) rock. The compacted rock surface was first given a penetration coat of asphalt followed by a leveling course of asphalt concrete. The asphalt mix, spread by hand, was deposited from dump trucks lowered down the slope by cables. A single pass of a vibratory roller compacted the mix. The rest of the asphalt facing was placed by a conventional paving machine modified to operate on the slope; it was supplied by dump trucks lowered to the paver by cables. At the toe of the dam (Figure IV-14) the asphalt lining curves out on a 3-m (10-ft) minimum radius until it is horizontal. It hooks over the concrete cutoff wall and is also keyed into the wall. In this manner, the water pressure helps to provide a watertight seal at this point.

The lining was placed in three lifts to build up the 30-cm (12-in.) thickness, including the thickness of the leveling course. Each paving strip was 3.7 m (12 ft) wide and was offset at least 0.9 m (3 ft) from the paving strip of the lower layer. Cold paving joints were coated with hot asphalt cement prior to placing the adjoining paving strip.

Montgomery Dam has measured up to performance expectations in all respects. Settlement of the rockfill has been very slight--less than 3 cm (0.1 ft). Close observation of the discharge from the dam's drainage system indicates continued integrity of the asphalt lining. Minor cracks that have appeared in the surface of the lining have been confined to the top paving layer, and they have been routinely filled. Additionally, no damage to the asphalt lining has been experienced from ice or winter conditions.

4.09 HOMESTAKE DAM--Homestake Dam, completed in 1967, is a compacted rockfill structure with an impermeable asphalt concrete facing on the upstream slope. Approximately 76 m (250 ft) high and nearly 610 m (2,000 ft) long at the crest, the dam is located in the Colorado Rockies about 19 km (12 miles) northwest of Leadville, Colorado, at an altitude of more than 3,000 m (10,000 ft).

The dam is a zoned, rolled rockfill embankment. The asphalt concrete facing is keyed into the foundation bedrock at the toe by a concrete cutoff wall. A single line of

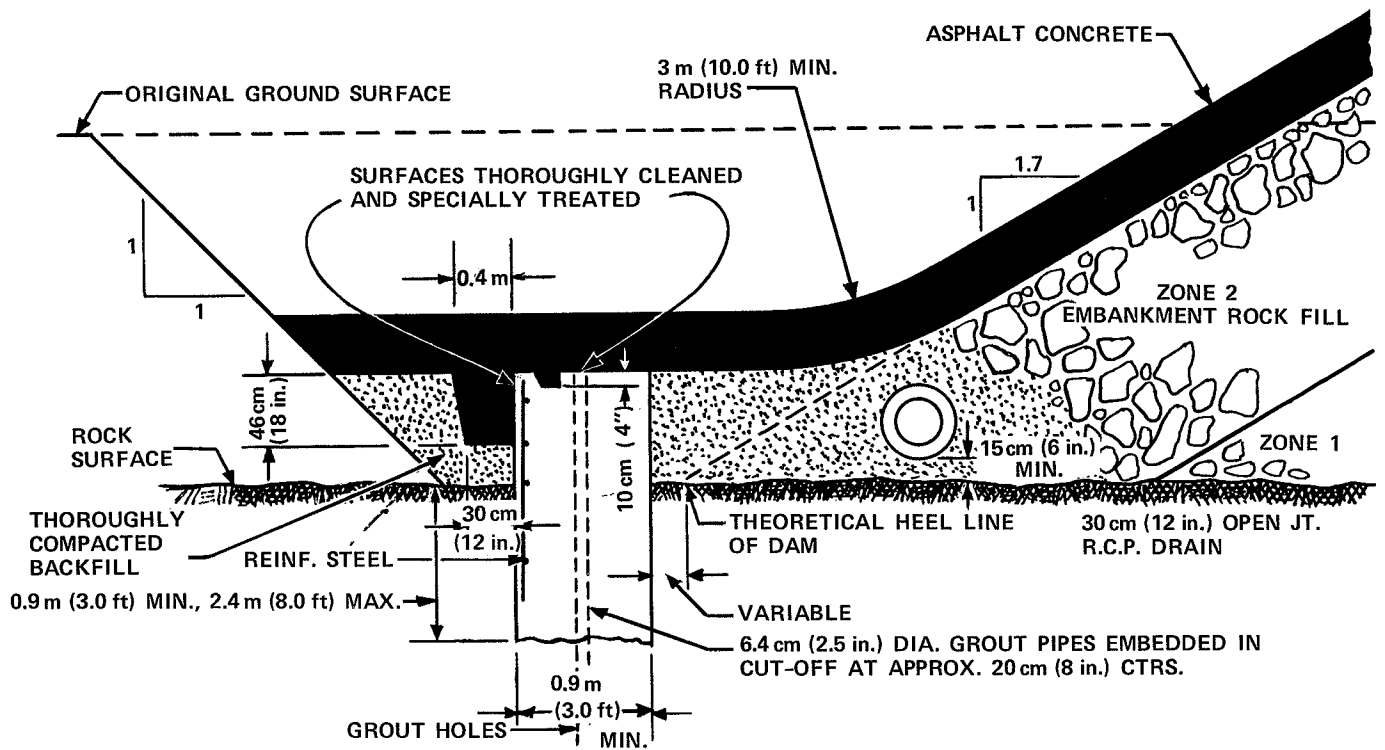

FIGURE IV-14. Cross-section of toe of Montgomery Dam, Colorado.



FIGURE IV-15. Paving operations, Montgomery Dam, Colorado.

grout holes extends into the foundation from the cutoff. A concrete parapet wall extends the crest a short distance above the dam as additional protection against high waves.

The waterproofing layer of asphalt concrete was placed on the compacted slope of the dam in 9-cm (3-1/2-in.) layers. The thickness of the facing varies from 36 cm (14 in.) at the toe to 18 cm (7 in.) as shown in Figure IV-16. Aggregate from a sand and gravel deposit downstream from the site was used for the asphalt concrete mix. The grading limits for the blended crushed gravel and sand were:

Passing	25.4 mm (1 in.)	100 percent
"	19.0 mm (3/4 in.)	88-94 "
"	12.7 mm (1/2 in.)	79-85 "
"	9.53 mm (3/8 in.)	72-78 "
"	4.75 mm (No. 4)	59-65 "
"	2.00 mm (No. 10)	44-48 "
"	425 μm (No. 40)	27.5-30.5 "
"	180 μm (No. 80)	17.5-20.5 "
"	75 μm (No. 200)	9.2-12.2 "

The asphalt cement content (50-60 penetration grade) was 7.4 percent.

The asphalt concrete was laid on the face of the dam by a paving machine modified to operate on the slope (Figure IV-17). Paving strips 3 m (10 ft) wide were placed as the laydown machine was pulled up the slope. The paver was fed by buckets that had been filled at the plant. The buckets were swung over the face by a crane with a 37-m (120-ft) boom. A special winch, side-mounted on the crane, raised and lowered the paver on the dam face. Compaction was obtained with four passes of a 4.1-tonne (4-1/2-ton) vibratory roller, also modified for operating on the slope, as shown in Figure IV-18. The roller was raised and lowered from a winch on a second crane.

As the rockfill embankment was completed in stages, each of which was approximately 20 m (65 ft) in height, the asphalt lining was placed and compacted. It was also advisable to place the lining in stages to keep the distances between the paving equip-

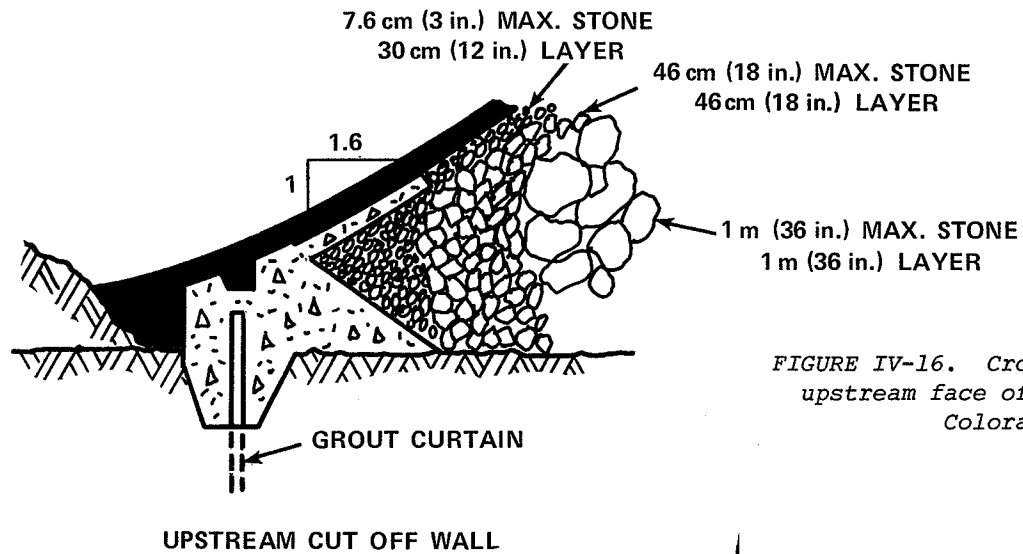
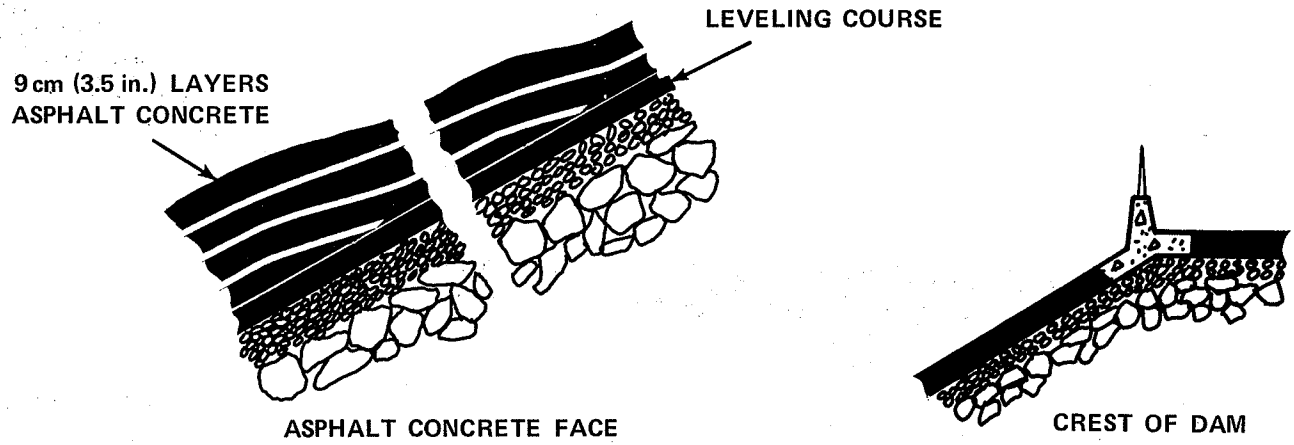

FIGURE IV-16. Cross-section of upstream face of Homestake Dam, Colorado.

FIGURE IV-18. (Right) vibratory roller with modified frame for compacting the asphalt concrete facing, Homestake Dam, Colorado.

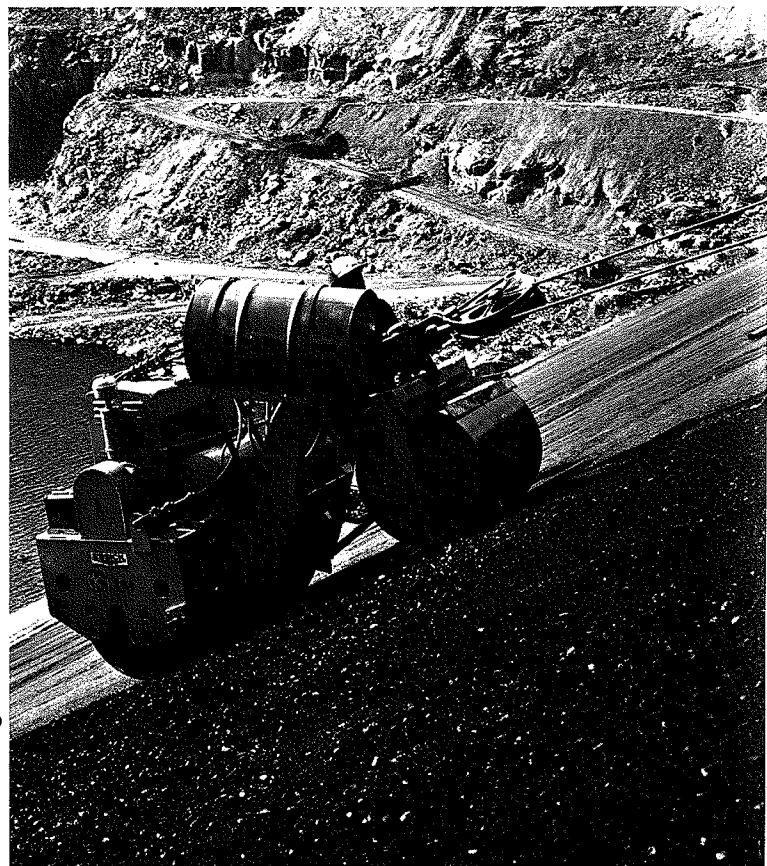
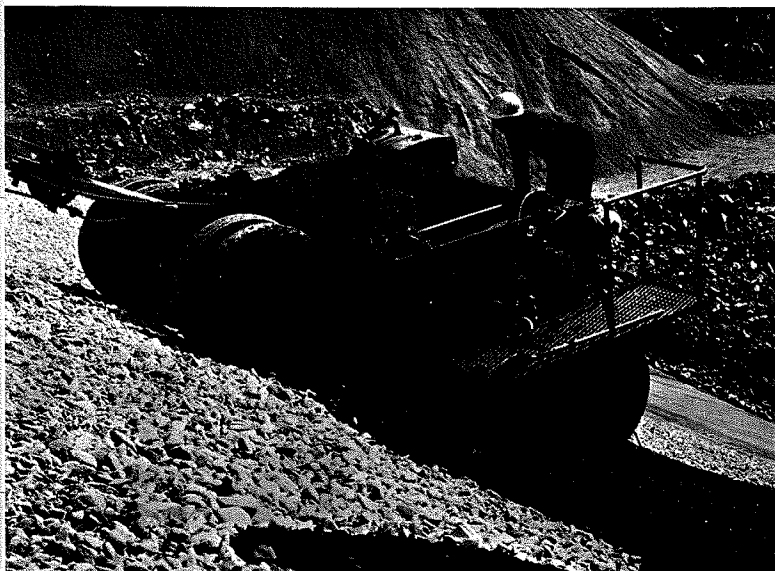

FIGURE IV-17. (Below) Modified paving machine placing leveling course on Homestake Dam, Colorado.



ment on the sloped face and the winching equipment within workable limits.

4.10 INTERNAL ASPHALT CORES FOR DAMS-- All of the earth and rockfill dams in the United States, and most of those in Europe, incorporating asphalt construction have the upstream slope paved with asphalt. However, there has been a trend in Europe toward internal asphalt cores, particularly in earthquake areas or where large settlements are expected. Two types of mixes have been used for constructing asphalt cores. The first, referred to as stone-asphalt, is simply a hot asphalt mastic with large stones, 10 to 41 cm (4 to 16 in.), embedded in the mass, constituting 35 to 45 percent of the volume. The other type is a well-graded impermeable asphalt concrete.

Stone-asphalt cores are either vertical or nearly vertical, and usually have a thickness of 0.9 to 1.1 m (3 to 3-1/2 ft). Construction of the core involves several steps: cleaning and precoating the stones, placing steel forms, mixing and placing the asphalt mastic, embedding the stones, and removing the steel forms. The forms, about 0.76 m (2-1/2 ft) deep, are set in place over the previous layer. Stone is used to backfill on either side of the forms to a depth of 40 to 50 cm (16 to 20 in.) or equal to the depth of core layer to be placed. The forms are then partially filled with hot asphalt mastic to a depth of 20 to 30 cm (8 to 12 in.). Following this, some of the precoated stones are placed on top of the mix and allowed to sink. The forms are then removed and additional stones are placed on top of the mastic and pressed into the mix with a specially designed vibrator (Figure IV-19). This also forces some of the mastic into the adjoining stone and interlocks the core with the rock fill.

Construction of internal cores with asphalt concrete has been made possible by the relatively recent development of a special machine by a German contractor. A front view of the machine is shown in Figure IV-20. An infra-red heater, projected forward of the machine and protected by a metal housing, heats the surface of the previous asphalt lift. Crushed stone is placed immediately in front of the machine. As the apparatus moves forward, a strike-off blade separates the crushed stone, and a layer of asphalt concrete is placed in the resulting channel. The stone layers are about 0.9 m (3 ft) wide on either side of the asphalt core and at the same thickness. This is shown in Figure IV-21. The asphalt core may be up to 1 m (3 ft) wide and as much as

25 cm (10 in.) thick for each pass. Vibrating screeds compact the stone and asphalt as they are placed. Additional compaction may be obtained with independent rolling.

All internal asphalt concrete cores constructed by this method have been vertical. Typical thicknesses of the core wall at the base are about 60 cm (24 in.) and they taper to about 30 cm (12 in.) at the top.

4.11 ASPHALT CUTOFF WALL, CLAYTOR DAM-- An asphalt cutoff wall was constructed about 1940 in the north abutment of the Claytor Dam hydroelectric project on the New River near Radford, Virginia. A hot sand-asphalt mastic was poured into a sheeted trench which was sunk through the overburden to rock. The trench was 104 m (340 ft) long, less than 1.2 m (4 ft) wide and varied from a few metres up to 46 m (150 ft) deep (see Figure IV-22). Its construction was necessary to check underflow through the north abutment of the dam, which consisted of dolomite rock, badly cut by solution channels and overlaid with rock fragments and clay. The cutoff wall was flexible enough to adjust, without cracking, and without losing its impermeability, to slight movements caused by temperature differentials or settlement.

After many tests of various sizes and gradings of aggregates, 88-1/2 percent manufactured dolomite sand and 11-1/2 percent 190 penetration grade asphalt cement were selected for the job. The gradation of the sand was:

6.35 mm (1/4 in.)	100	percent passing
2.00 mm (No. 10)	80.5	" "
425 μm (No. 40)	41.0	" "
150 μm (No. 100)	24.5	" "

The mixing temperature was 168°C (335°F). Since the mixture stayed fluid for some time, it was possible to pour the asphalt mastic at a rate limited only by the production capacity of the mixing plant and the capabilities of the haul trucks. This rapid placement of the mix maintained sufficiently low viscosity that the mastic was able to flow into all parts of the trench and into all surrounding spaces, thus completely embedding the sheeting. The solution passages were so tightly packed with the mastic mix that even small cracks in the rock were filled for some distance from the trench.

4.12 ASPHALT INJECTION FOR SEEPAGE CONTROL--Leakage through the underlying strata of dams, reservoirs, or abutment

sections may be controlled by the pressure injection of asphalt into the leakage channels. This use of asphalt has been effective under conditions (such as appreciable heads and water velocities) that result in the carrying away of other grouting materials.

Relatively hard, high-softening-point asphalt cements have generally been used for these purposes. The hot, fluid asphalt is pumped through heated pipes let down into drilled holes. The pipes have perforations at the leakage strata levels. Once in the leakage channel, the asphalt spreads out to a considerable extent and hardens into a tight plug or water stop.

An example of hot asphalt injection is that used to control leakage in the dam at Great Falls Reservoir, Tennessee. The leakage that developed after increasing the height of the dam represented a power loss of 14 percent. Operations to control the leakage began in 1945, some 20 years after the height of the dam was increased 11 m (35 ft). Portland cement grout was pumped through drilled holes wherever it could be

used. Where rapidly flowing water was encountered, hot asphalt was injected. As a result, leakage was reduced by about 98 percent. Indications are that this treatment is still holding firm against leakage.

An experimental asphalt injection project was set up by the U. S. Bureau of Reclamation at Morrow Point Dam in Colorado in 1971. Leakage had increased around the limits of the cement grout curtain on the left abutment established during construction in 1968. A cationic asphalt emulsion triggered with a hydrated lime slurry was the first step taken to plug the large water channels. The asphalt was pumped through a pipe inserted in drilled exploratory holes. A separate pipe for the lime slurry was also inserted. As the asphalt and lime slurry emerged under pressure, they mixed. The lime caused the emulsion to agglomerate into a stringy mass which adhered to the rock surface as it contacted it under water, thus plugging the leakage channels. After the asphalt injection had reduced the leakage, the curtain was extended and completed with a cement grouting program.

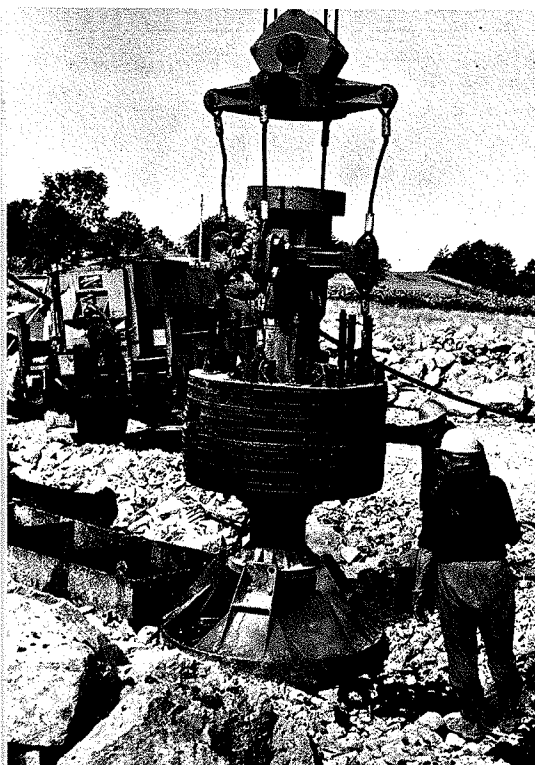

FIGURE IV-19. A heavy vibrator forcing stones into the hot asphalt mastic core.

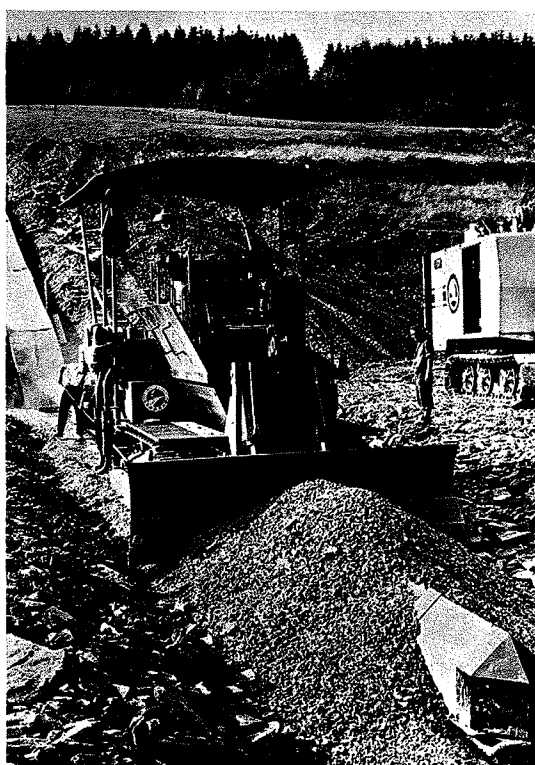

FIGURE IV-20. Front view of special machine for asphalt core construction.

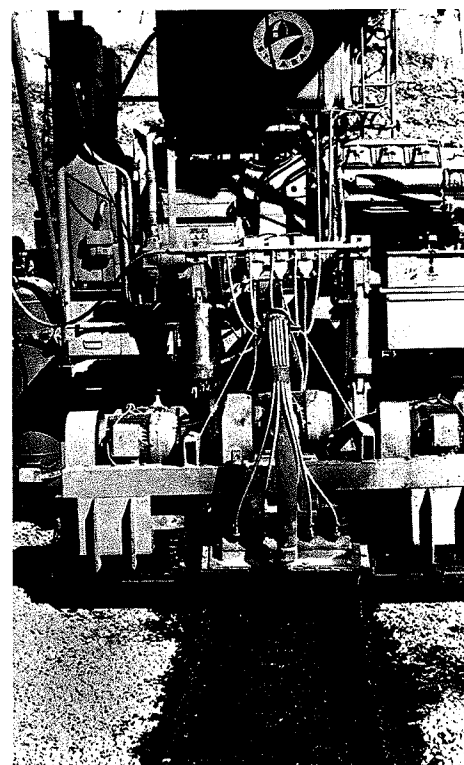

FIGURE IV-21. Rear view of special machine for asphalt core construction.

(Photographs courtesy Shell International Petroleum Company.)

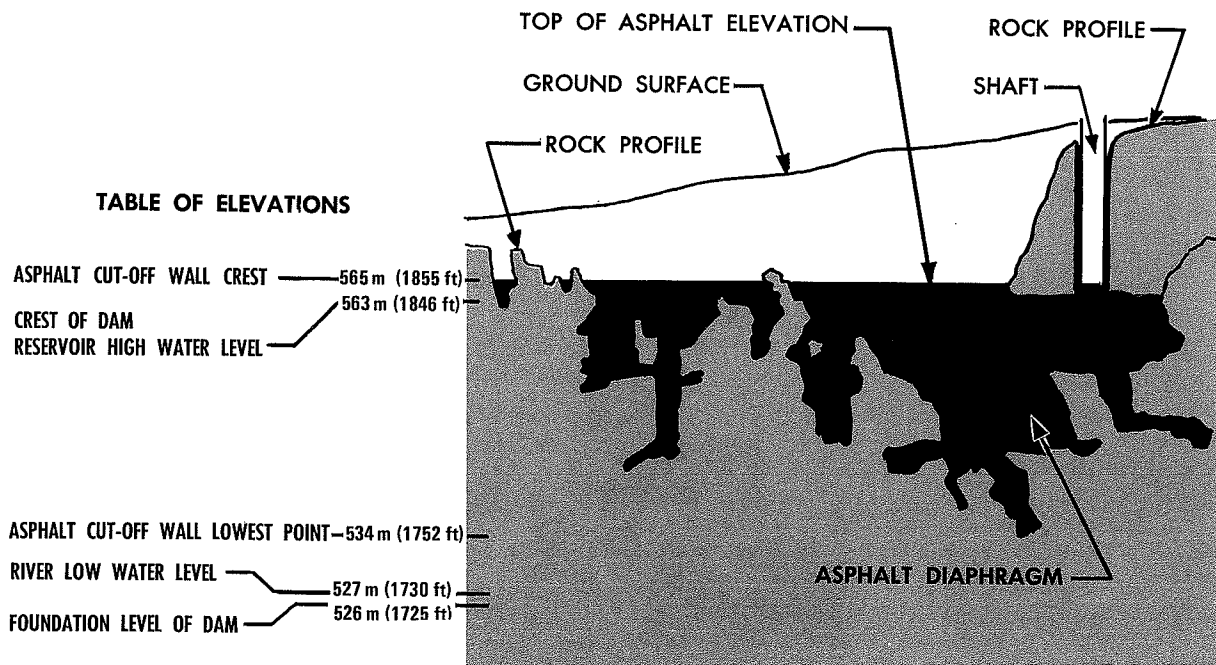

FIGURE IV-22. Longitudinal cross-section of asphalt cutoff wall, Claytor Dam, Virginia.

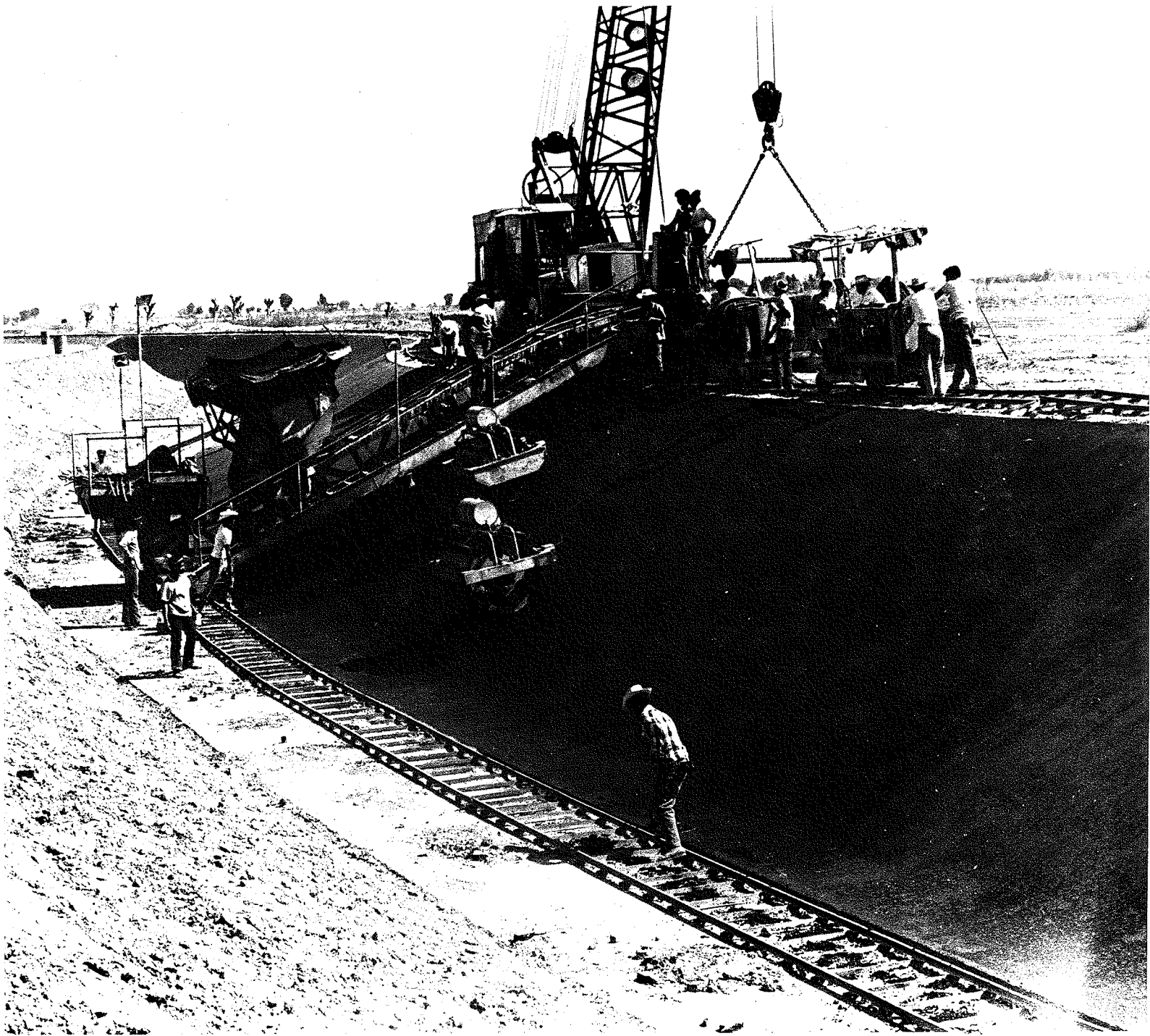

FIGURE V-1. Construction of asphalt concrete lining on Canal Alimentadore del Norte, Baja California, Mexico.

CHAPTER V

ASPHALT IN CANALS AND DRAINAGE CHANNELS

A. CANALS

5.01 GENERAL--The purpose of an irrigation canal is to convey efficiently the required quantity of water from source of supply to point of delivery. In many cases the cost of lining a canal is justified by the increased efficiency with which it serves this purpose.

Lining a canal reduces seepage. Reduced seepage means that a smaller cross-sectional area can deliver the required quantity of water, since it is unnecessary to provide for water otherwise lost in transit. Reduction of seepage is further desirable because water leaking from unlined hydraulic structures often collects in low-lying lands, rendering them unfit or unproductive.

The U. S. Bureau of Reclamation has been responsible for most irrigation canal installations in the United States. The Bureau has tried several types of asphalt construction for the protective lining of canals. Most of these lining installations have been either asphalt concrete or buried asphalt membrane. In recent years, the buried asphalt membrane has become the most popular.

5.02 ASPHALT CONCRETE CANAL LININGS--Asphalt concrete is an effective lining for canals and laterals. Such a lining is smooth, erosion-resistant, durable, relatively impermeable, and has excellent hydraulic properties. (Manning coefficient of roughness, n , is approximately 0.014.) The minimum thicknesses for asphalt concrete canal linings are shown in Table V-1. These are based on canals having trapezoidal cross sections, base-width to water-depth ratios from 1 to 2, and having side slopes no steeper than 1.5:1. Thicknesses greater than 10 cm (4 in.) should not be required except under extraordinary circumstances.

Asphalt concrete canal linings are usually placed and compacted by methods and equipment designed or adapted especially for the purpose. For example, on one lining placement job, the hot mix was dumped into a portable hopper that had a short conveyor belt for depositing it on the side slopes.

TABLE V-1

MINIMUM RECOMMENDED ASPHALT CONCRETE
CANAL LINING THICKNESSES
(U.S. Bureau of Reclamation)

Canal Capacity m^3/s (ft^3/sec)	Minimum Lining Thickness, cm (in.)
Less than 6 (200)	5 (2)
6-42 (200-1500)	7.5 (3)
Over 42 (1500)	10 (4)

Timbers were set up and down the slope at 3.4- to 3.7-m (11- to 12-ft) intervals to guide a heavy steel screed that was pulled up the slope by a dragline, to smooth and partially compact the mix. To aid compaction, a plate vibrator was welded to the screed. Final compaction was accomplished by a single, steel-wheeled roller.

It is customary in this type of work for a single steel-wheeled roller to be maneuvered by a line from a tractor winch or crane boom. In some cases two lines, one from each direction, are used. Often some hand tamping must be done in places the roller cannot reach, such as the junction of the invert with the side slope.

In other cases, specially constructed spreader boxes can also be used. Where canal bottoms are wide enough and have a minimum of sharp bends, standard paving machines and rollers should be used.

Specially designed and manufactured slip-form lateral and canal pavers (Figure V-2) offer best economy and efficiency. These machines normally ride skids in the excavated and trimmed earth ditch. However, sometimes they are mounted on low-pressure pneumatic-tired wheels. Each machine has a hopper into which the hot asphalt mix is dumped. The mixture is spread, struck off to the proper thickness, and finally smoothed and compacted by a heated, weighted,

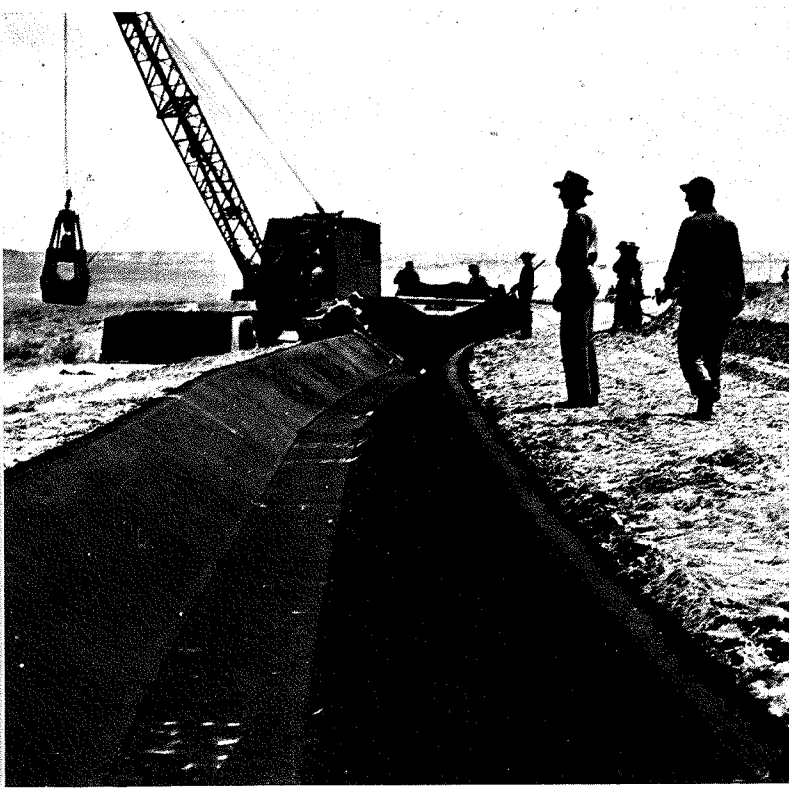

FIGURE V-2. Lining a canal with a slip-form paver.

vibrated and independently-controlled ironing screed at the rear of the machine. With this, no additional compaction is necessary. A slip-form paver can be towed by a tractor, or by a power winch mounted on the tractor or on the paver itself. The strike-off screed must be provided with independent controls, by section, to regulate the thickness of the finished linings. Also, thickness and grade alignment are best controlled when the forward pull is along the centerline of the canal.

Most installations of asphalt concrete canal and lateral linings on record are those of the U. S. Bureau of Reclamation. The earliest were placed in the Contra Costa Canal, Central Valley Project, California, and in the Snipes Mountain Canal, Yakima Project, Washington, both in 1939. In 1947, some 74,000 m² (88,000 yd²) of asphalt concrete canal lining were placed on the Pasco Pump Lateral System near Pasco, Washington, using, for the first time, a specially-designed slip-form paving machine. These pavers also placed the lining of the Ygnacio Canal, Central Valley Project, California, and the lining on some of the canals and laterals of the Riverton Project in Wyoming. In 1957, approximately 33,000 m² (40,000 yd²) of a 10 cm (4 in.) thick lining were placed on the downhill slope of the New York Canal, Boise, Idaho. The Bureau has installed more than 290,000 m² (350,000 yd²) of asphalt concrete linings on more than 77 km (48 miles) of canals.

Disintegration and deterioration have occurred in some of the Bureau's older portland cement concrete linings; especially on surfaces that have been constantly exposed to erosion, scour, and temperature extremes. Asphalt concrete, usually 3.8 cm (1-1/2 in.) thick, has been used successfully to overlay these portland cement concrete linings--some 100,000 m² (120,000 yd²) of them.

For the most part, these installations have performed satisfactorily. Throughout the years, maintenance has been limited. The earlier linings, constructed without the benefit of experience, did not last as long as those built more recently. Nevertheless, lining installations on some projects have provided good service for more than 25 years.

5.03 BURIED ASPHALT MEMBRANE CANAL LININGS--Buried asphalt membrane construction was developed by the U. S. Bureau of Reclamation in cooperation with the asphalt industry to provide an efficient, low-cost means of controlling seepage in earth-lined irrigation structures. The first installation was in a lateral of the Klamath Project, near Klamath Falls, Oregon, in 1947. Since that time, the Bureau has covered over 6.7 million m² (8 million yd²)--or over 720 km (450 miles) of canals and laterals with asphalt membrane lining.

These linings, several of which have been in service for more than 20 years, and have been adequately protected by earth cover, are giving excellent service. To date there have been no cases reported where deterioration of the asphalt itself has contributed to failure of the membrane, when the proper asphalt was used at the recommended temperatures. The few failures that have occurred can be attributed to poor construction procedures and movement or loss of cover material. The buried asphalt membrane has

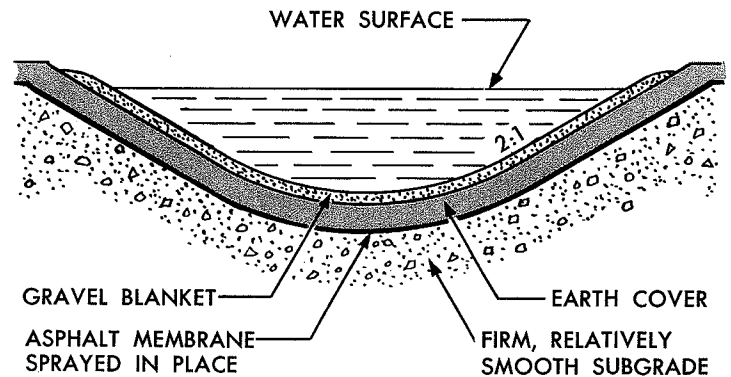

FIGURE V-3. Cross-section of buried asphalt membrane-lined canal.

proved to be an efficient, low-cost way to control seepage. Normally, maintenance has been limited to repairs to the cover materials.

5.04 PREFABRICATED ASPHALT PANEL LININGS--The Bureau of Reclamation has built numerous trial sections of prefabricated asphalt panel canal linings. Since 1953, approximately 68,000 m² (81,000 yd²) have been installed in California, Arizona, Nevada, Colorado, Idaho, Montana and Wyoming, to evaluate the effects of climate and subgrade conditions. Periodic observations have shown that the prefabricated asphalt panel performs satisfactorily, provided that the joints remain watertight and hydrostatic pressure is not allowed to build up under the lining. Prefabricated asphalt panels are essentially a complete lining, performing the combined functions of seepage control and erosion resistance, without the need of a protective cover. As shown in Figure V-4, the panels are installed over a smooth-rolled and sterilized subgrade. Special equipment and skilled workmen are not needed. Panels have also been used to resurface deteriorated concrete linings.

5.05 MISCELLANEOUS--Asphalt penetration macadam linings have been used by the U. S. Bureau of Reclamation on an experimental basis, as protection for underlying membrane linings and for compacted earth embankments. The first installations were made on the Bureau's experimental canal farm in 1950. Since then, the Bureau has installed 9,200 m² (11,000 yd²) of macadam lining on canal projects in California, Wyoming and Montana.

Pneumatically-applied asphalt linings--a mixture of fine sand and slow-setting emulsified asphalt--have also been tried by the Bureau. Application equipment is essentially the same as that used for pneumatically-placed portland cement concrete. Test installations were completed on the Orland and Central Valley canals, California, in 1954. To date the Bureau has installed 12,500 m² (15,000 yd²) of this type of lining for resurfacing concrete-lined channels as well as for initial linings. Thicknesses have varied from 2.5 to 7.5 cm (1 to 3 in.).

Undersealing old concrete canal linings with asphalt is not a lining procedure but it has been important as an economical method of lining rehabilitation. Two areas of badly-cracked and poorly-supported old concrete linings on the Riverton Canal, Wyoming, and Yakima Ridge Canal, Washington, were undersealed by the U. S. Bureau of Reclamation in 1949 and 1950. Definite benefits were apparent on the Riverton pro-

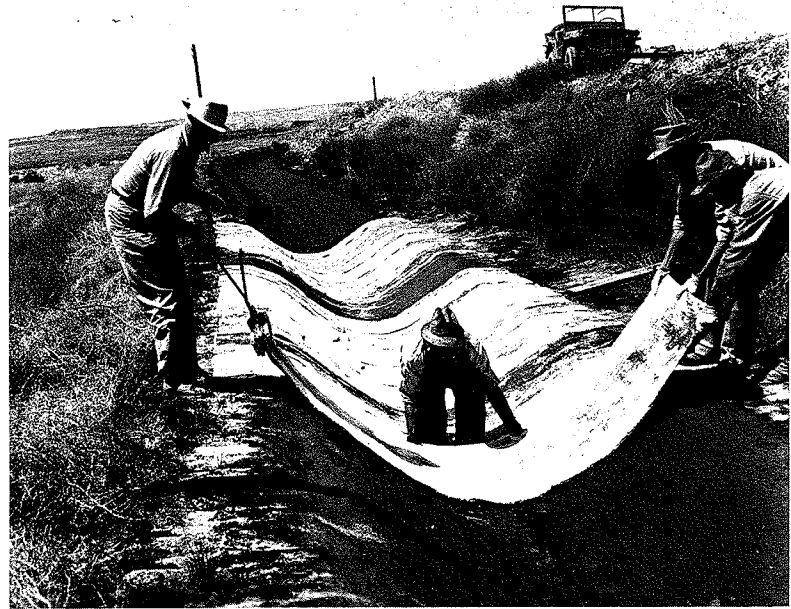

FIGURE V-4. Lining ditch with prefabricated asphalt panels.

ject but some leakage persisted in the Yakima Canal. It was felt that this was occurring beyond the treated area. The section was resurfaced with 5 cm (2 in.) of asphalt concrete in 1957. Since then, the paving seal has been completely effective.

B. DRAINAGE CHANNELS

5.06 GENERAL--Asphalt concrete has long been used to line storm channels and drainage ditches, varying from shallow highway or street gutters to large, river-size channels. The main purpose of such a lining is to give the channel good hydraulic properties and to prevent erosion--that is, to protect its banks and nearby property from the destructive effects of water. The linings of storm channels must be durable, tough, and resilient enough to meet the severe conditions of high water velocity and turbulence that are frequently accompanied by scouring sand and high impact forces of boulders and debris. Experience has proved that a properly-designed, dense asphalt concrete lining can successfully meet these conditions.

Asphalt concrete storm channel linings are usually 7.5 cm (3 in.) thick. However, thicknesses of 15 to 23 cm (6 to 9 in.) have been placed where severe turbulence, velocities in excess of 4.6 m/s (15 ft/sec) or hydrostatic back pressures are encountered. For small ditches, 5 cm (2 in.) thicknesses

may be satisfactory. Since impermeability is not generally a requirement for channel linings, it is a good idea to provide drains through the lining at points where back pressure is likely to develop. Normally, the entire channel is lined but, in some cases, particularly with larger channels, only the side slopes or banks are lined.

In situations where only the sides have been paved, various methods have been used to protect the revetment from scour and undercutting at the toe of the slope. An effective one has been to extend the asphalt paving some 1.2 to 1.8 m (4 to 6 ft) below the stream-bed level. This can be done only if the channel is dry at the time of construction. Another method has been to place heavy riprap at the toe of the lining.

The use of wire reinforcement is not recommended unless severe scour and undercutting are anticipated. Then about 10-cm (4-in.) woven mesh of a 14 to 16 gauge galvanized wire is used. Ties should be made about every 10 cm (4 in.) using wire of the same gauge as the mesh. The reinforcement should be securely anchored to the slope by metal stakes or ties to some form of "dead men." The wire should be placed at about the midpoint of the asphalt concrete. This can be done by placing

expensible props under the wire, or by using hooks to pull the wire up into the mix after it is placed but before it is compacted.

Construction methods closely follow those already described for canal linings. Small channels and ditches may be lined by hand or by special slip-form canal lining machines. In larger channels, the asphalt mix may be placed by various combinations of standard paving equipment, specially designed slope pavers, hand raking and spreading using timber forms to guide strike-off screeds. Compaction may be done with conventional tandem rollers, single-wheeled rollers, or with modified compaction equipment.

Asphalt concrete storm and drainage channel linings have been used extensively in installations throughout the United States. Their greatest use has probably been in the Pacific Coast area where flash-flood conditions are particularly severe, and where intense land development has made strict confinement of storm-water runoff necessary to prevent large property damage and loss of land by erosion. The Orange County and Los Angeles County Flood Control Districts in Southern California have been leaders in this field.

FIGURE VI-1. Roller operated by a drag line compacts the asphalt revetment, San Joaquin River, California.

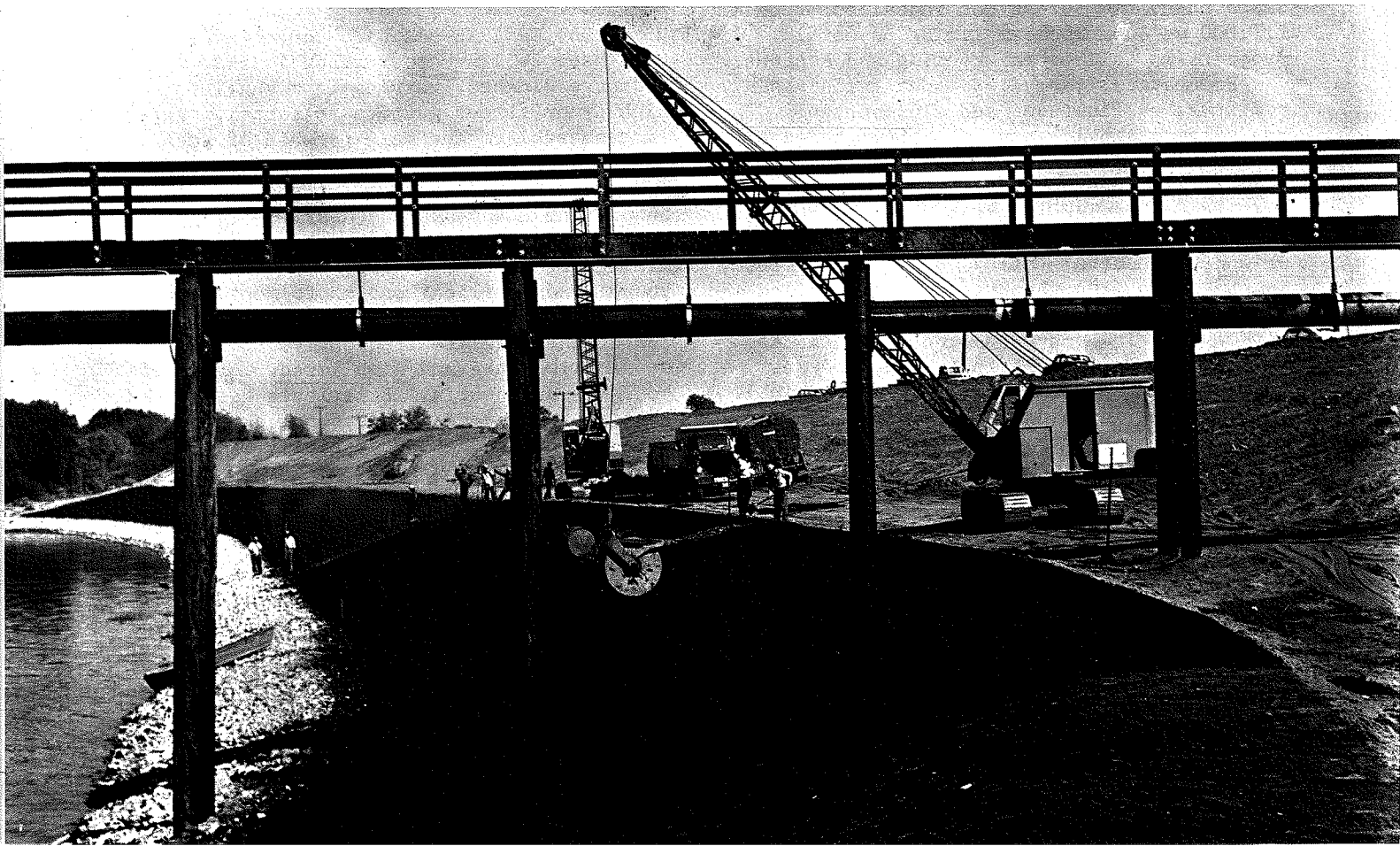

CHAPTER VI

ASPHALT IN BANK PROTECTION

6.01 GENERAL--The most common cause of bank failure is erosion at the toe of the slope. The slope steepens until it fails by subsidence or sliding. Other causes of failure are simple erosion of the channel and sloughing of completely saturated banks. The latter usually happens when there has been a protracted flood stage followed by a rapid fall of the water level.

A revetment is a continuous cover designed to protect a river bank from the destructive effects of water currents. It interposes an erosion-proof layer between the unstable material of the bank and the moving water. To protect against bank failures, the ideal revetment should: (1) Completely cover the area to be protected; (2) possess sufficient strength to withstand the attack of the river; (3) be designed so it will not be damaged by hydrostatic uplift pressures; (4) be flexible enough to conform to the irregularities of the riverbank and stream bed; (5) be impermeable enough to prevent material from leaching through the pavement; (6) have a long life; and (7) not be prohibitively expensive.

Asphalt mixes, properly designed and constructed, possess the necessary qualities. Once constructed, a dense, paved layer gives complete coverage. The excellent condition of asphalt revetments in place for more than 35 years attests to the strength and durability of asphalt in water, or under attack by water. Asphalt revetments can be made as impermeable as desired; or they can be made porous to permit drainage of groundwater from the riverbank to prevent damaging hydrostatic uplift pressure. They are sufficiently plastic to conform to minor irregularities of the bank, and they usually prevent major irregularities from forming. Locally available aggregates can often be used to economically produce mixes having these qualities.

Some precautions should be considered in designing a protective riverbank revetment. Scouring of material from around the edges of the revetment must be prevented. The upstream end must be keyed into, or other-

wise anchored to the embankment itself, to keep moving water from undermining and eventually displacing the pavement. The bottom edge of the revetment should also be protected. If it does not cover the stream bed, the revetment should either be extended into the bed beyond the scour zone or have stone riprap or comparable protection. The top edge should also be protected from scour by stream water when overtopping or flooding, and from surface water runoff. The downstream edge of the revetment should be anchored to the bank to eliminate potential damage from eddy currents. Finally, if an impermeable lining is to be placed, the same precautions for preventing hydrostatic uplift pressures from groundwater levels in the bank should be taken as for reservoir or canal linings.

Asphalt for bank protection is described in Chapter V, where drainage channel protection is discussed, and also in Chapter VII where paved banks for coastal protection are described.

6.02 MISSISSIPPI RIVERBANK PAVING--Almost all important riverbank protective structures in the United States have been developed and constructed under the direction of the U. S. Army Corps of Engineers. The bulk of them have been on the Mississippi River and its tributaries.

Reinforced asphalt mattresses, developed by the Corps for use on the lower Mississippi River, were formed on a floating plant and placed as the subaqueous portion of a riverbank revetment. They consisted of an asphalt mastic layer 5 cm (2 in.) thick reinforced by wire mesh and a system of cables. The mattresses were laid in water depths as great as 52 m (170 ft) in a continuous sheet approximately 66 m (215 ft) wide (measured parallel to the river) and up to 192 m (630 ft) long. They were waterproof except for a weep hole for each 9 m² (100 ft²) of area, to allow for drainage from the riverbank. Successive overlapping mattresses formed a continuous revetment. Following placement, the upper bank (portion of the

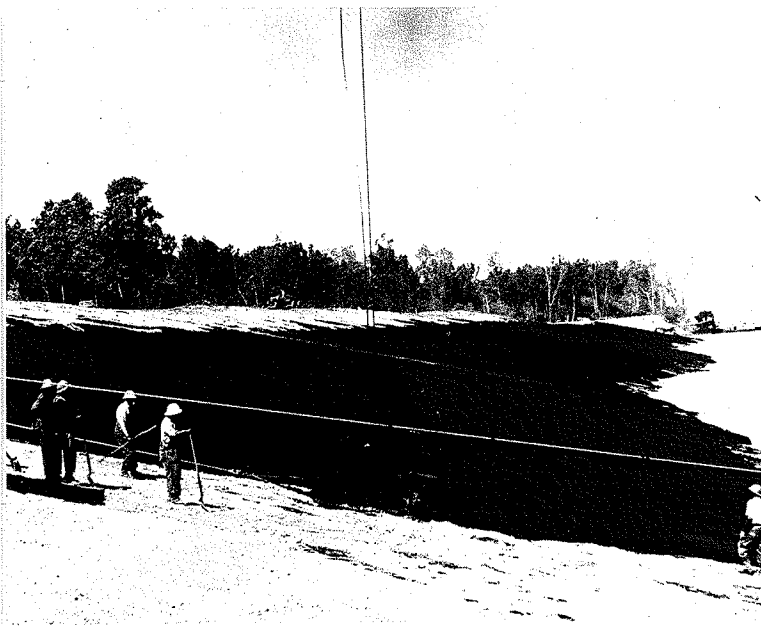

FIGURE VI-2. Placing mix by spreader box.

bank above water) was paved to complete the bank protection.

The Corps worked experimentally with dumping asphalt hot mix en masse for the protection of underwater slopes. The theory was that, by dumping large masses of hot sand-asphalt mixtures through a depth of water on a sloping bank, they would spread out to form a blanket or cover before the mix cooled.

A large-scale placement was made on the Mississippi River near Vicksburg in 1947. The mix consisted of local bar sand passing the 2.00-mm (No. 10) sieve with 10 to 11 percent asphalt cement, 85-100 penetration. The mix was prepared by a floating plant and was deposited in a bottom-dump barge. When the barge was positioned, the asphalt was dumped while hot in 236 tonne (260 ton) masses. Though the deposited mix did spread out to form a blanket, adjacent dumps did not entirely seal together as expected.

Another method used was the dumping of partially formed sand-asphalt blocks retaining enough heat and plasticity to bond together on the river bottom to form a continuous blanket. The mix consisted of local bar sand with asphalt content of 6 to 8 percent. Placed in pans but not compacted, the mix was allowed to cool partially and then was dumped 70 blocks at a time to cover 9 m^2 (100 ft^2).

Upper bank paving was usually performed as a separate operation immediately after placing the underwater portion. One type of bank protection the Corps of Engineers has used successfully is the 13-cm (5-in.) layer of porous, uncompacted sand asphalt. The porous mix permitted drainage of the bank, eliminating damaging back pressures.

The bar-run sand that was used contained virtually no material passing the $150 \mu\text{m}$ (No. 100) sieve. The mix typically had an asphalt content of 6 percent. It was prepared by a floating asphalt plant and was placed by spreader boxes of 7.6 to 9.2 m^3 (10 to 12 yd^3) capacity (Figure VI-2) pulled up the bank slope by a tractor winch. This type of revetment performed effectively and had an estimated useful service life of at least 20 years.

6.03 SAN JOAQUIN RIVER--The U. S. Army Corps of Engineers constructed an experimental bank protection revetment of asphalt concrete on the San Joaquin River near Tracy, California, in 1959. The project was divided into two sections on a sharp bend of the river. The first section was 229 m (750 ft) long and consisted of a compacted asphalt concrete revetment. The second section 244 m (800 ft) long, consisted of uncompacted asphalt concrete.

The bank, which had become badly eroded, was reconstructed and sloped in preparation for placing the revetment. The embankment was first sprayed with a poly-borchorate soil sterilant to prevent weed growth. Quarry stone was then placed on the underwater portion of the 3:1 slope. For the compacted asphalt concrete section, a 15 cm (6 in.) bedding layer of crushed stone 4-cm ($1\frac{1}{2}$ -in.) maximum size, was placed, compacted, and primed with MC-70 cutback asphalt at 1.8 litres/m^2 (0.4 gal/yd^2). After the prime coat had cured, the asphalt concrete was placed on the slope above the quarry stone and compacted to a 7.5-cm (3-in.) thickness. The paving also consisted of a 1.5-m (5-ft) berm along the top edge anchored into the bank by a 30 x 30 cm ($12 \times 12 \text{ in.}$) asphalt concrete cutoff wall.

A typical section of the compacted asphalt concrete section is shown in Figure VI-3. The asphalt paving on the slope was compacted with a 2.7-tonne (3-ton) roller operated with a drag line (Figure VI-1). The top edge of the paving was compacted by hand tamping against a 5 x 30-cm (2 x 12-in.) board which was later removed.

The uncompacted asphalt concrete section was placed immediately downstream from the compacted section. This section differed from the previous section in that the crushed stone bedding layer was omitted and the asphalt paving was placed on the primed soil to a depth of 13 cm (5 in.). The asphalt concrete for the compacted section consisted of a well-graded aggregate 19-mm ($\frac{3}{4}$ -in.) maximum size, and 5 percent asphalt cement. The aggregate for the uncompacted asphalt section was finer-graded with 38-mm ($1\frac{1}{2}$

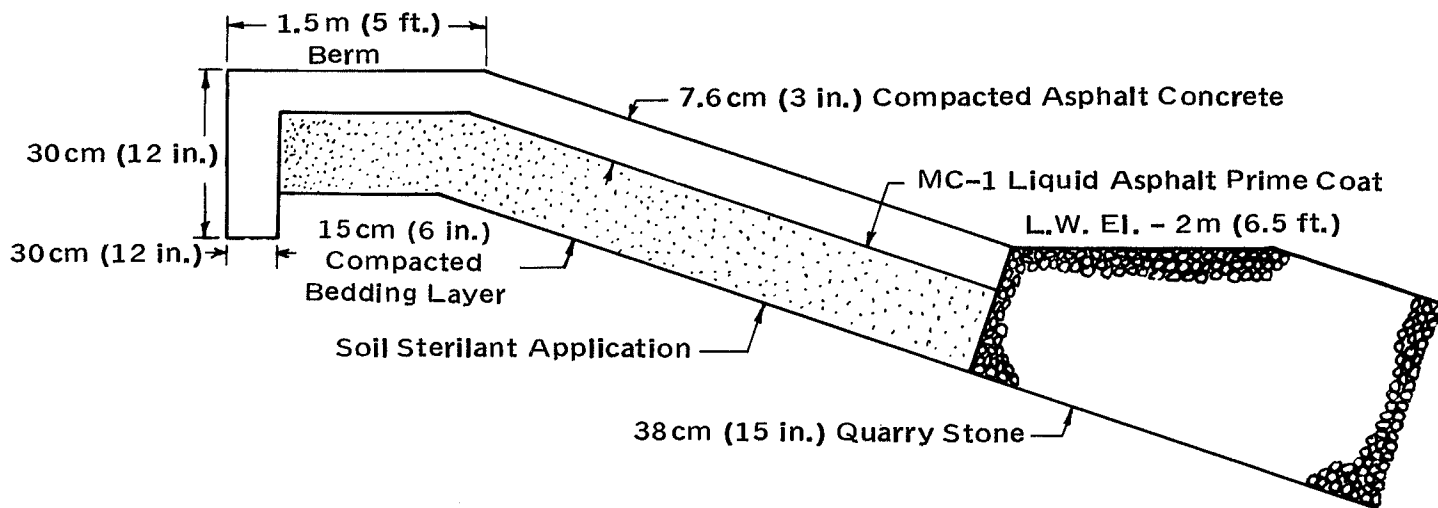

FIGURE VI-3. Typical section of the compacted asphalt concrete section, San Joaquin River, California.

in.) maximum size stone particles and was mixed with 5.3 percent asphalt.

The most severe test of the two sections occurred during the 1968-69 flood season when water velocities exceeded 1.2 m/s (4 ft/sec) against the paved sections and 2.1 m/s (7 ft/sec) in midstream. After 12 years of service and no maintenance, the compacted section was in excellent condition with no cracking or abrasive loss. The uncompacted portion experienced some minor shrinkage portion and the surface had some abrasive loss.

6.04 ASPHALT GROUTED GABIONS--The use of sand-asphalt mastic for grouting stone or rubble layers to form relatively impervious coast and riverbank protection has been well known in Europe for many years. Also the use of gabions as building elements for pervious protective layers is a well-established technique. However, the combination of these two forms of construction is a relatively new concept that has evolved more recently.

Gabions are cages of woven, galvanized steel-wire mesh filled with stone. The mesh gauge and stone sizes are such that stone will not slip through the wire openings, and that the cage will be strong enough to substantially retain its shape. The gabions are wired together to form a mattress, or stone cover, a wall, or even a groin.

The asphalt mastic is poured on to the finished surface from chutes, dumps, or crane buckets, and spread with squeegees. For optimum penetration of the voids in the

stone [down to 10-cm (4-in.) size], the viscosity of the mastic should be about 100 Pa·s (1,000 P) at the time of placing and spreading. The application rate depends upon the extent and characteristics of the voids in the stone layer.

Grouting operations may also be carried out underwater. This may require some adjustment in the composition of the mix and application methods. Although the surface of the grouted stone layer is usually left rough, an asphalt concrete surface may be placed over the grouted surface, if desired, or a surface treatment may be applied. Care should be taken to employ the type of construction and to use materials that are suitable to the temperature and service conditions to which the structure will be subjected.

An example of an asphalt-grouted stone gabion layer (or mattress) is the bank protection along the Bristol Channel at Llanelly, South Wales, United Kingdom. A typical cross-section is shown in Figure VI-4. The 15 cm (6 in.) thick gabion mattress was placed directly on the sandy bank and filled with 7.5 cm (3 in.) quarried limestone. Sand-asphalt mastic grouting was applied at about 125 kg/m² (230 lb/yd²).

Another example is that in the Po River delta at Lido Degli Estensi, near Ferrara, Italy. A portion of the bank for a flood-relief channel was covered with a gabion layer 25 cm (10 in.) thick containing quarried stone 7.5 to 10 cm (3 to 4 in.) in size. The gabion was grouted with a sand-asphalt mastic at the rate of 152 to 163 kg/m² (280 to 300 lb/yd²).

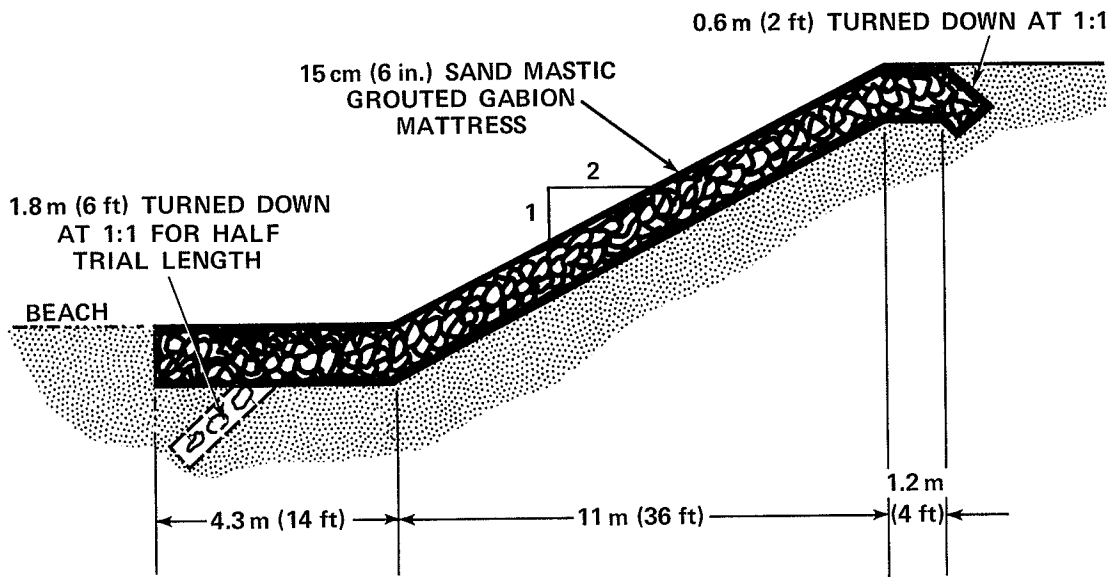

FIGURE VI-4. Typical cross-section of asphalt-grouted gabion mattress, Bristol Channel, South Wales, U.K.

FIGURE VII-1. Asphalt jetty affords excellent protection to sandy beach, Asbury Park, New Jersey.



CHAPTER VII

ASPHALT IN COAST-PROTECTION STRUCTURES

7.01 GENERAL--The principal types of coast-protection structures for controlling erosion are seawalls, breakwaters, bulkheads, jetties, and groins. Each performs a different function. Beaches are the most effective means of dissipating wave energy, and, when they can be maintained to adequate dimensions, afford the best protection for the shore area and adjoining upland. In general, seawalls and bulkheads are built where it is necessary to maintain the shore or prevent erosion. They are also constructed where it is desirable to maintain a depth of water along the shore line, as for a wharf. Long groins (jetties), extending well out into the water, are used to help form beaches and build them up to the desired width by trapping material from the littoral drift. Shorter groins with low profiles are used to maintain beaches at desirable widths by retarding or preventing loss of material to the littoral currents.

Engineers have made considerable use of asphaltic materials in the construction of many structures for coastal protection. Asphalt concrete is used to pave or revet the slopes and tops of earth or sand seawalls; it may also be used to pave, or cap, the top surfaces of rock jetties, breakwaters, and groins. Asphalt mastic mixtures are used for grouting to fill-in the voids of stone or rock jetties and groins, and for the rock riprap facing of seawalls.

7.02 GALVESTON JETTY--Grouting and capping of the Galveston Jetty in 1935-36 was the first large-scale use of this type of asphalt construction in the United States. The south jetty at Galveston, Texas, consisted of a rubble-mound of 35-kg (75-lb) to 1.8-tonne (2-ton) core stone covered by cap and slope stones weighing 5 to 9 tonnes (6 to 10 tons) as shown in Figure VII-2. The foundation was a mat of small stones 7 to 91 kg (15 to 200 lb) each. The jetty had deteriorated in grade and cross-section through foundation settlement, through grinding of core stones on each other, and through displacement of cover and core stones by wave action during storms. Also, littoral

currents had carried sand through the previous structure, thus increasing maintenance dredging of the channel.

In 1935 the U. S. Army Corps of Engineers decided to seal and cap the jetty with asphaltic material to prevent infiltration of sand and to lengthen the life of the entire structure. Various grouting-type asphalt mixes were used. One of the most successful consisted of 70 percent Galveston beach sand, 12 percent Mississippi River loess (filler), and 18 percent asphalt cement, 30-40 penetration. The asphalt mastic was placed at 204°C (400°F). Care was taken in dumping it into the rock structure to obtain maximum penetration into the voids both above and below the water. Long-handled vibrators were used to facilitate penetration. A stiffer mix, used to cap the structure above water, was also compacted by vibration and smoothed by tampers to form a traffic way. The experiment proved highly successful; see Figure VII-3.

7.03 PORT AUSTIN BREAKWATER--The capping of 133 steel cells of the Port Austin, Michigan, breakwater illustrates another use of asphalt for water control structures. This work was accomplished under the direction of the U. S. Army Corps of Engineers in 1958. The 581 m (1906 ft) breakwater consists of 67 main cells, 4.7 to 9.3 m (15-1/2 to 30-1/2 ft) in diameter, connected by sixty-six 2.4-m (8-ft) cells, all filled with gravel. See Figure VII-4. The asphalt cap consists of a 5 cm (2 in.) base course of a dense, sand-asphalt mix placed over the compacted gravel fill which had been given a prime coat. A second layer of sand asphalt, also 5 cm (2 in.) thick, formed the top surface which was sloped at 1 percent. Heated to about 177°C (350°F) the mix was hauled a distance of 68 km (42 miles) from the plant in insulated trucks. Temperature loss was not more than 5.5°C (10°F) during the trip. The trucks, using a temporary dredged road that followed the curvature of the breakwater, dumped their loads into a box. A clam-shell bucket then lifted the

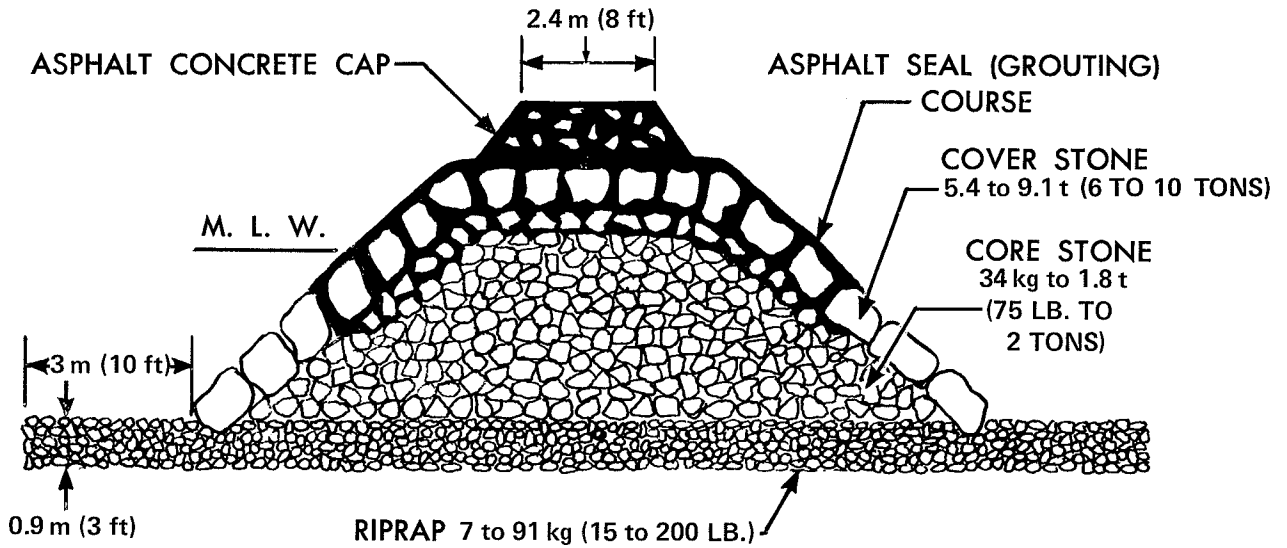

FIGURE VII-2. Cross-section, South Jetty, Galveston, Texas.



FIGURE VII-3. Galveston Jetty after fifteen years of service.



FIGURE VII-4. Asphalt-capped cellular breakwater, Port Austin, Michigan.

mix to the tops of the cells. It was spread by rake and shovel and then compacted by hand tampers and vibrating hand compactors.

7.04 COASTAL PROTECTION, THE NETHERLANDS --Following extensive trials of various types of grouting and other protective treatments on the Isle of Urk in 1936, large-scale grouting of groins (jetties) with sand-asphalt mastic began in 1938 on the coast near The Hague. The structures are still in

good condition. Since 1946, when work was resumed, asphalt grouting has been used in such structures as groins, jetties, harbor walls, and canal and riverbank revetments. Following the severe floods of 1953, when urgent and extensive repairs were necessary, asphalt concrete was introduced for such work. But since there was insufficient time between tides for placing the thick layers required to resist uplift pressures, asphalt mastic grouting in critical zones was resumed in 1961.

In the Delta scheme, it was necessary to protect large areas of the sea bed against scour in the closure gaps of the dams. Special apparatus was developed that could place sand-asphalt mastic continuously and evenly in a strip 5 m (16 ft) wide in water up to 30 m (100 ft) deep. This equipment was also used for laying asphalt mastic carpets on the sea bed.

A ship was equipped with a vertical insulated supply pipe with filling gates at different heights and a horizontal distributor with outflow pipes at the bottom, (see Figure VII-5). The distributor, Figure VII-6, was heated with oil and had various control devices. A feeler connected to the distributor kept the nozzles at a constant height from the bottom. An asphalt mixing plant on board prepared the mix. The mastic was deposited into a stirring kettle which supplied the distributor.

7.05 ASPHALT-CAPPED SEAWALLS, CALIFORNIA --Los Angeles Harbor, 1939, was the scene of a noteworthy example of the use of asphalt concrete to stabilize a stone seawall. Tidal action and storms had caused the Outer Harbor Dock and Wharf Company to lose much of the stone riprap underneath its wharf. A careful laboratory study of the stabilities and densities of various mix designs produced a well-graded mix having 8 percent passing the 75 μ m (No. 200) sieve and 6 percent asphalt cement (40-50 penetration) content.

Trucks delivered the mix and dumped it through a narrow opening in the dock flooring on to the rock of the seawall. The temperature of the mix at that point was approximately 163°C (325°F). Tamping to proper cross-section was accomplished by air hammers equipped with suitable heads. Initial tamping below water level was done during low tides, and further dumps were heaped on the lower lifts in order to build up the capping gradually and maintain heat sufficient to obtain good bond. The finished capping and reconditioning job was 107 m (350 ft) long with 1:1 slopes on each side and 0.6 m (2 ft) across the top. The structure has provided protection to installations located over and behind it and has remained in excellent condition.

More recently, an asphalt mastic mix was used to consolidate the stone of the seawall protecting the seaside swimming pool of the city of Palos Verdes Estates, California. Storm damage was threatening the enclosing brick wall and foundation of the swimming pool. The seawall was restored to grade and profile, then grouted and capped in one operation by end dumping the hot mix from trucks. After dumping, the mix

was raked, screeded, and tamped into place. The asphalt mix consisted of sand, crusher dust, and 12-15 percent 200-300 penetration grade asphalt cement. This installation has withstood the pounding waves of several severe storms. (Figure VII-7.)

7.06 SLOPE PROTECTION--Asphalt revetments may be used to protect the exposed seaside slopes of earth or sand structures (seawalls, breakwaters, natural slopes). These are very similar to the asphalt-paved bank protection structures discussed in Chapter VI, but they usually are built much thicker and heavier in order to resist the heavier attacks to which they are subjected.

The use of asphalt paving on a seawall slope is illustrated in Figure VII-8. The underwater revetment shown is riprap grouted with a sand-asphalt mastic for reinforcement. The junction of the underwater and above-water portion of the revetment is a critical point. As shown here, it is protected by sheet piling which should be driven 1.5 to 2 m (5 to 6 ft) deep. The above-water revetment is a well-graded impermeable asphalt concrete. This can be placed on most seawall slopes with conventional paving machines since the slopes usually are no steeper than 3:1.

The use of asphalt paving for seaside slope protection is much more common in Europe than in the United States. One such use in the United States is the revetment on both sides of a road causeway in southern Maryland. This 670 m (2,200 ft) causeway connects Point Lookout (where the Potomac River empties into Chesapeake Bay), to State Route 5. The causeway had been damaged by five different major storms, including a 1954 hurricane when waves from the Bay broke through the narrow strip of land and opened a channel 9 m (30 ft) wide and 2.4 m (8 ft) deep to a natural lagoon on the other side. The slope protection was completed in 1956-57.

First, heavy treated-timber sheeting was driven to protect the toe of the slope. On the Bay side, this sheeting was reinforced by 30-cm (12-in.) timber piles on 6-m (20-ft) centers. The 4:1 slopes were then paved with two 5-cm (2-in.) layers of asphalt concrete. Welded wire fabric reinforcing 0.6 m (2 ft) wide was placed between the two courses along the toe of the slope and anchored to the sheet piling by nails and bolted timber wales. Paving was accomplished with conventional paving equipment.

Through the years, the paved slopes have successfully withstood other storms as well as visitors and sightseers using the area for parking their vehicles.

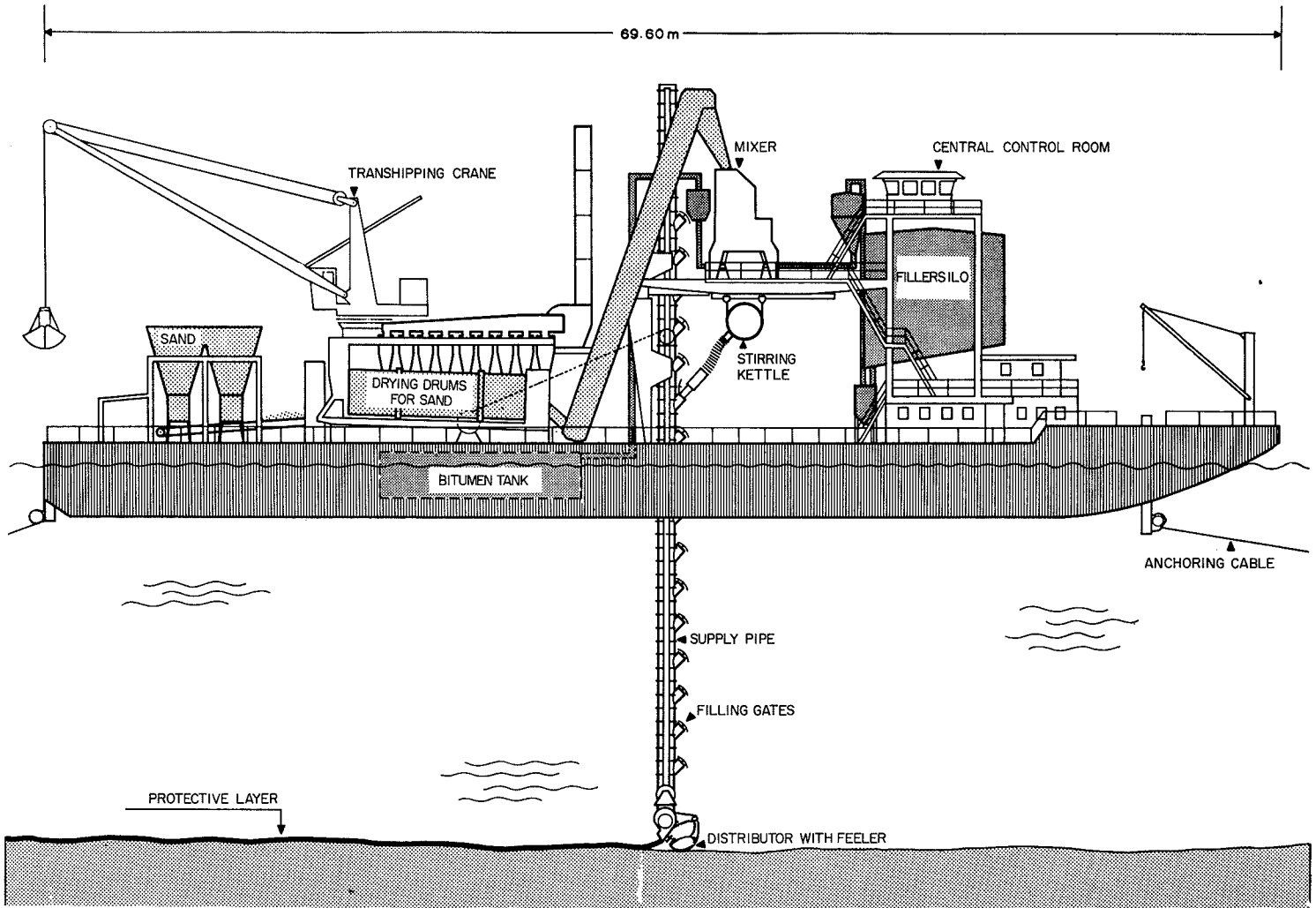

FIGURE VII-5. Drawing of the asphalt ship "Jan Heymans" showing the mixing plant and special underwater mastic placing apparatus.

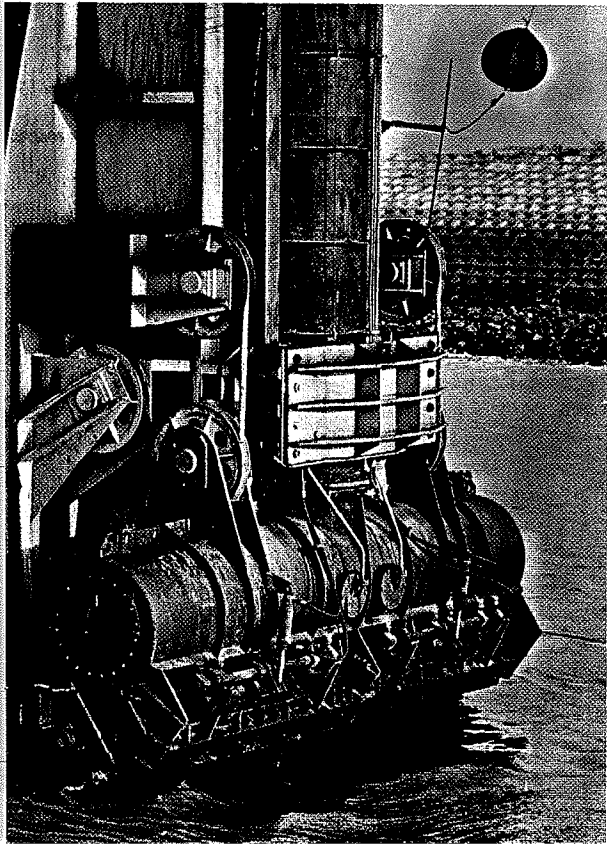

FIGURE VII-6. (Left) Horizontal distributor for placing the asphalt mastic underwater; (Kerkhoven, AAPT Proceedings, 1965).

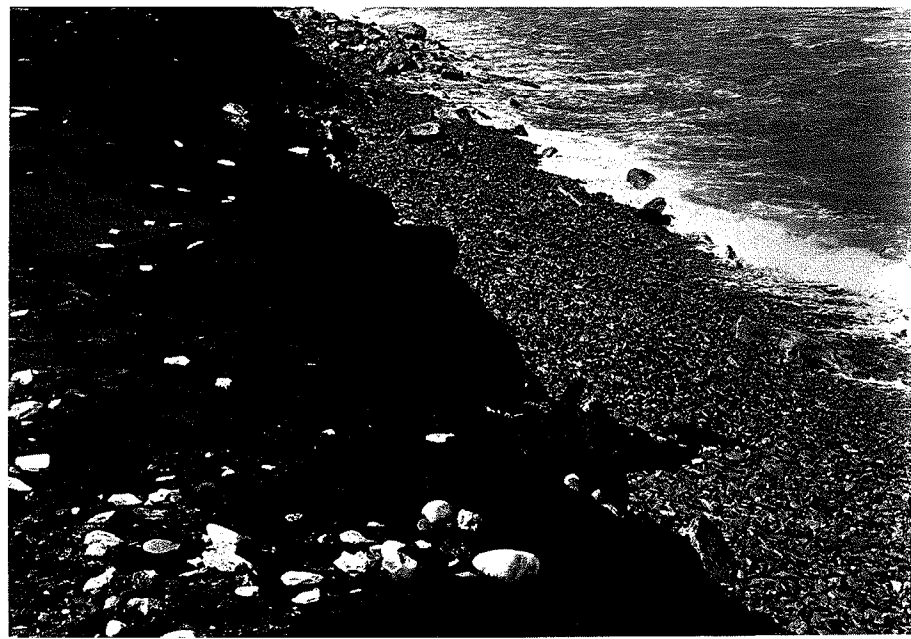

FIGURE VII-7. Asphalt-capped seawall, Palos Verdes Estates, California.

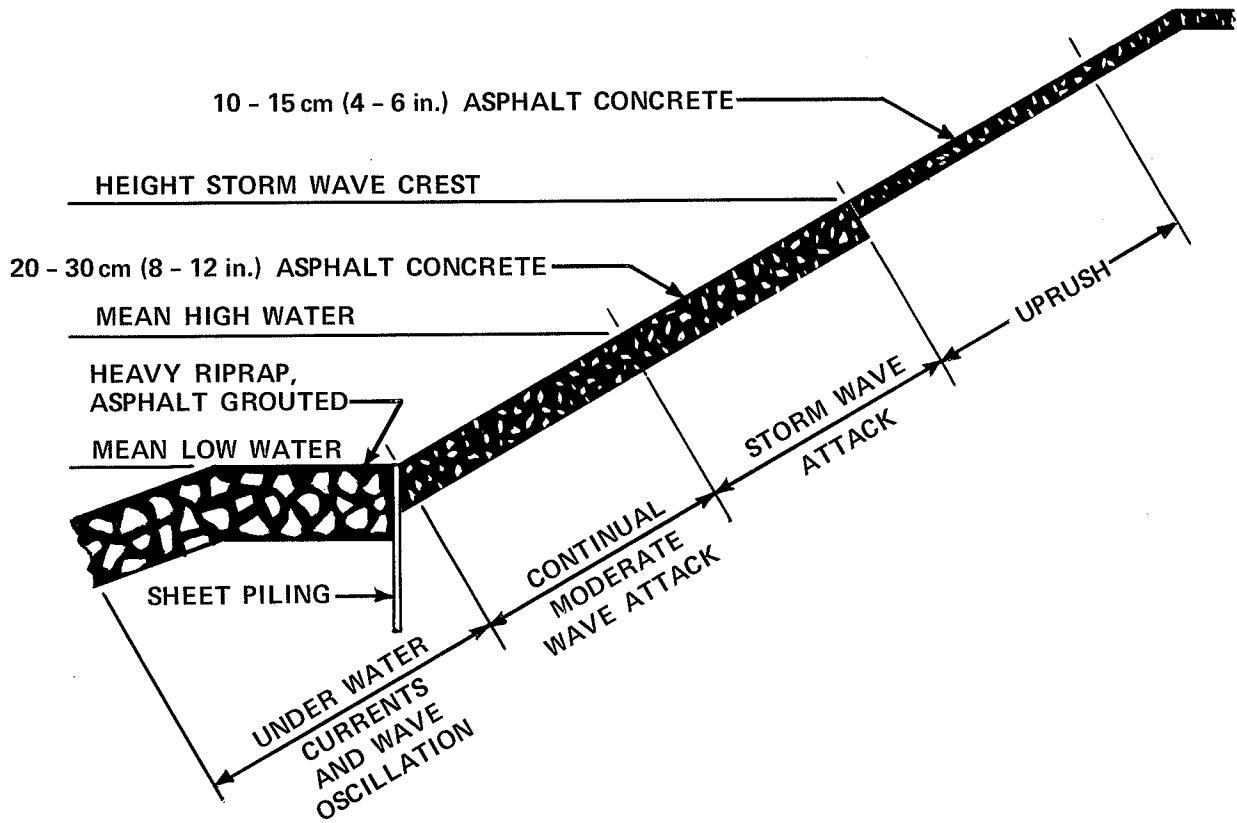

FIGURE VII-8. Seawall slope revetment.



*FIGURE VIII-1. Asphalt-lined brine-storage reservoir,
Lapeer County, Michigan.*

CHAPTER VIII

ASPHALT IN MISCELLANEOUS USES

8.01 GENERAL--Asphalt can be used in a variety of hydraulics and waterproofing applications. The linings for small, shallow reservoirs such as swimming pools, ponds, lagoons, and the like are fundamentally similar, in design and construction, to those found in the larger reservoirs. Many installations store contaminated or waste solutions such as sewage or brine. Here asphalt plays an important role by containing these solutions and preventing groundwater pollution. Being an inert material, asphalt is stable in the presence of chemical concentrations found in most domestic and industrial waste, except for substantial amounts of petroleum-derived wastes.

As more and more emphasis is placed upon pollution control, engineers are finding that asphalt offers an economic and effective means of lining waste reservoirs as well as waste and chemical storage areas. It has been used to line and waterproof sanitary landfills, to construct salt storage pads, line garbage scows, and for many other applications. Doubtless, additional effective uses of asphalt for related purposes will be found.

8.02 ASPHALT LININGS FOR SANITARY LANDFILLS--In the United States, 90 percent of solid waste is disposed of on land, making essential a sound approach to solid waste management. Sanitary landfills, in which layers of waste are covered with layers of earth, with restorative grading and planting as the last step, are excellent replacements for the formerly-common open and burning dumps. However, even sanitary landfills can pose a pollution problem; namely, the contamination of groundwater caused by rainwater percolating through the deposited waste and leaching pollutants into the groundwater. The proper control of leachates is therefore necessary, and for this purpose asphalt, historically proven as a most durable waterproofing material, is recommended as a pollution-eliminating lining for sanitary landfills. An asphalt landfill lining can be either (a) a hot-

sprayed asphalt membrane, or (b) a layer of compacted hot-mix asphalt concrete. Both types are becoming more common as environmental requirements become stricter.

Several asphalt membrane-type sanitary landfills have been constructed in the State of Pennsylvania. One was built in the summer of 1974 for the West Berks County Refuse Authority near Reading, Pennsylvania. Now comprising seven acres, this sanitary landfill ultimately will encompass some 20 hm² (50 acres).

In preparation for the asphalt membrane, the subgrade was graded and trimmed. Next, a 15-cm (6-in.) sand and gravel subbase was placed and compacted. The air-blown asphalt cement membrane was then sprayed in several passes for a total application rate of 9 litre/m² (2 gal/yd²), resulting in an approximate thickness of 1 cm (3/8 in.). Following the membrane, a 46-cm (18-in.) layer of permeable cover material was placed. Although not yet distinguished by longevity, this installation is fairly typical of a number of recent membrane-type, asphalt-lined sanitary landfills.

The asphalt-concrete-lined sanitary landfill is typified by an installation at Rockford, Illinois. In 1972, an abandoned gravel pit was lined and is now receiving from 450 to 540 tonnes (500 to 600 tons) of solid waste per day.

Before placement of the lining, the side slopes and bottom of the pit were graded to ensure that leachate is conducted over the sloped bottom to a ditch, thence to a perforated drain and ultimately to a 76-m³ (20,000-gal) steel tank. Contents of the tank are pumped back over the fill to accelerate deterioration of the solid waste. Five centimetres (2 in.) of asphalt concrete, using 200-300 penetration asphalt cement, line the bottom and side slopes of the first stage of this landfill. A tar emulsion sealer protects the lining against naphtha or other solvents inadvertently dumped in the fill. Fifteen centimetres (6 in.) of sand cover the paved bottom and side slopes.

The first stage of the landfill has been filled, and the lining has been extended with

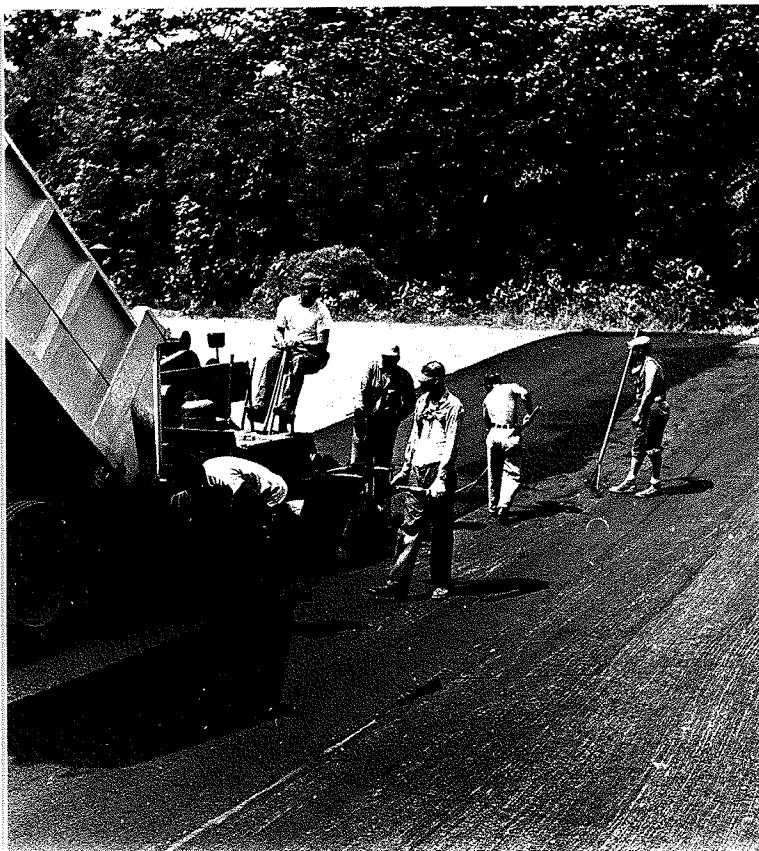

FIGURE VIII-2. Placing the binder course on the Wallingford swimming pool, Connecticut.

an emulsified asphalt paving mixture. This has also been given a seal coat and covered with 15 cm (6 in.) of sand. Known as the Winnebago County Land Reclamation Site, the landfill is serving a population of 200,000. In addition to a letter of commendation from the Illinois Environmental Protection Agency, its merits have been recognized in a national environmental publication.

8.03 ASPHALT-LINED SWIMMING POOLS--

Because of its inherent qualities, asphalt concrete is an excellent material for lining or paving large recreational swimming pools. Used alone or in combination with other asphalt materials, it can provide a durable, impermeable lining with a smooth surface that is easy to clean and maintain. In essence, a pool is simply a reservoir, or pond, with certain special construction details added. The same principles and mix requirements are utilized. Because swimming pools are emptied periodically for cleaning, it is particularly important to see that hydrostatic groundwater pressure is eliminated. Hence the subgrade must be a carefully compacted course with positive means for draining off excess groundwater. Subgrade side slopes should not be steeper than 2:1, with gentler slopes preferred; although this may somewhat restrict swimming space in a small pool, it may

actually enhance the design of a large recreation-type pool.

A very large pool was constructed in 1960 by the city of Wallingford, Connecticut, as part of its park and recreation system. The pool has a water surface area of more than 0.56 hm² (1.37 acre) and water depths ranging from 0.9 m (3 ft) at the shallow end to 2.9 m (9-1/2 ft) in the diving section. It existed for ten years as an unpaved community swimming pond, fed by a constant flow of water from a brook. Silt from the brook gradually created a thick layer of mud on the bottom. Finally, it was decided to create a modern swimming pool at this old site by constructing purification and desilting works for the water and paving the surface with a dense asphalt concrete.

Construction began with the removal of silt accumulated on the pool's bottom. A natural gravel subbase layer was placed and compacted on the natural sandy subgrade. Then a crushed stone base 10 to 15 cm (4 to 6 in.) thick was placed. The asphalt concrete lining was placed in two courses: a 5-cm (2-in.) binder layer which served as a leveling course and a 2.5-cm (1-in.) surface. The binder layer, shown being placed in Figure VIII-2, provided a reasonably smooth and stable operating base for the machines laying the rich, dense surface mix smoothly and evenly. The surface was then given a seal coat of emulsion with filler, and painted a suitable color. The pool has also been used in winter for ice skating. The overall condition of the asphalt lining has remained good.

Wading pools are shallow bowls with maximum depths of about 45 cm (18 in.). Their surfaces are not required to resist heavy, superimposed loads, either from water pressure above or groundwater pressure from below. Hence an asphalt-concrete lining 5 cm (2-in.) thick, properly placed and compacted on a well-drained substantial foundation, will usually provide a thoroughly adequate lining structure.

Since impermeable asphalt concrete surfaces are not affected by freezing, asphalt-paved swimming and wading pools may be converted into excellent ice-skating rinks.

The surfaces of asphalt-lined pools may be tinted and decorated with suitable paints. Paints having acrylic, asphalt, rubber, or water bases may be used. Oil-based paints should not be used, since oil is a solvent of asphalt. Asphalt concrete will not impart an offensive odor, taste, or other deleterious property to water. It has been widely approved for lining storage reservoirs for drinking water.

Properly constructed, asphalt-lined pools provide years of service with low maintenance. A swimming pool having an 8-cm (3-1/4-in.) asphalt lining was constructed in Montpelier, Vermont, in 1939. Since then, maintenance has been minimal.

Because regulations regarding swimming pools vary widely, all plans should be cleared with local authorities before beginning construction.

8.04 ASPHALT-LINED WASTE-TREATMENT LAGOONS--Sewage lagoons, industrial waste ponds, brine storage reservoirs, and the like, may be considered to be simply a type of storage reservoir as far as design requirements for an asphalt lining are concerned.

The hot-sprayed, buried asphalt membrane is particularly suitable for the construction of lagoons and other large shallow reservoirs. The soil cover over the membrane-lined bottom prevents it from being displaced by wave action, or by trapped ground gases that may be present underneath the membrane. Asphalt concrete is also well suited for lining sewage and other waste-treatment lagoons. It allows relatively easy cleaning of the facility. Prefabricated asphalt panel linings offer erosion-resistant and watertight linings with simple installation procedures.

A 40-hm² (100-acre) lake was constructed at the United States Army Rocky Mountain Arsenal near Denver, Colorado, in 1956. The lake was created by constructing a dike at one end of a natural swale to impound an area approximately 884 (2900 ft) by 488 m (1600 ft) with a capacity of about 1.2 x 10⁶ m³ (1000 acre-ft). The lake serves as an evaporation pond for the liquid waste from the arsenal. A hot-sprayed, buried asphalt membrane was installed to make the lake watertight.

In constructing the membrane lining, a strip of the lake bottom was excavated to grade and then rolled. The membrane was sprayed over the smooth, compacted surface in a 3.7-m (12-ft) wide strip. An asphalt distributor using an outrigger spray bar to one side (Figure VIII-3), built up a membrane thickness of 6 to 10 mm (1/4 to 3/8 in.) in three passes. Elevating graders, working in tandem, excavated the adjoining strip and at the same time placed the earth blanket on the asphalt membrane. The outer edge of the membrane was then cleaned before the next strip [which overlapped the previous one 10 to 15 cm (4 to 6 in.)] was placed.

The lake has been in continuous operation and completely watertight since its comple-



FIGURE VIII-3. Placing asphalt membrane lining, Rocky Mountain Arsenal, Colorado (U.S. Bureau of Reclamation).

tion. In 1971, however, some petroleum waste inadvertently was deposited in the lake, damaging a portion of the membrane. It was repaired. Otherwise, maintenance has been minimal.

In 1967 a 1890-m³ (500,000-gal) asphalt-lined reservoir was constructed to store brine for road construction and ice control in Lapeer County, Michigan. Measuring 37 by 85 m (120 by 280 ft), the 1.5 m (5 ft) deep reservoir was lined by placing a 7.5 cm (3 in.) thick hot-asphalt mat over the compacted sandy soil bottom, slopes and shoulders. A 3-m (10-ft) paver and a 1.8-tonne (2-ton) tandem roller were used to place and compact the mix. Although the compacted lining was essentially voidless, an asphalt membrane was sprayed over the surface to a built-up thickness of 3 mm (1/8 in.).

8.05 ASPHALT-LINED PONDS--Ponds, whether located on farms, in parks, on golf courses, in fish hatcheries, or elsewhere, may also be considered simply as water storage reservoirs as far as asphalt lining requirements are concerned. Unless the pond is to be drained from time to time, the design of drainage to prevent hydrostatic uplift pressures under the lining is not normally necessary. Because of the shallow depths involved, impermeable asphalt mix linings may generally be 4 to 5 cm (1-1/2 to 2 in.) thick. However, proper subgrade preparation and compaction are just as important for small ponds as for large reservoirs.

Hot asphalt mixes, sprayed asphalt membranes, prefabricated asphalt panels and linings, and combinations of these, may be



FIGURE VIII-4.
(Above) Asphalt-lined pool, General Motors "Futurama" exhibit at the 1964-65 World's Fair.



FIGURE VIII-5.
(Right) Prefabricated asphalt panel lined reflecting pool, City Water Department, Long Beach, California.

and have been used for lining ponds. The simple construction procedures associated with prefabricated asphalt panels often present an advantage, especially when the facility is too small to warrant the design, production, and placing of an asphalt mix or the installation of an asphalt membrane. Also, asphalt panels have been installed on the vertical sides of shallow pools, such as decorative or reflecting pools.

There are many instances of asphalt having been used for lining ponds or pools; some are shown in the following illustrations.

8.06 ASPHALT-PAVED ORE RECOVERY PADS--
The Anaconda Company has developed a method of recovering copper from waste piles at its Butte, Montana, mine. An acid-water solution is pumped over waste piles and leaches out some 80 percent of the less than 0.3 percent copper ore that is present in the waste. The liquid is recovered and the copper extracted. To be economically feasible, recovery of the solution has to be complete. This is made possible by an impermeable, asphalt-paved pad upon which the waste is placed for treatment.

Construction of the asphalt pad began with clearing the area of vegetation, grading and compacting the soil. To even the slope, a crushed stone base layer averaging 10 cm (4 in.) in thickness was then placed, compacted, and primed with an MC cutback asphalt. A 7.5-cm (3-in.) layer of impermeable asphalt concrete, using 7 percent asphalt cement, 85-100 penetration, was then placed over the primed base. This was followed by an asphalt membrane seal sprayed over the surface at a rate of about 1.6 litre/m² (0.35 gal/yd²). Since rock would be dumped from a height of up to 55 m (180 ft), a 2-m (6-ft) layer of waste was placed over the paved area to act as a cushion. (See pavement cross-section, Figure VIII-8.)

Temperatures in the area range from 32 to -48°C (90 to -55°F) at the 1800 m (6000 ft) elevation. With loadings on the mat reaching up to nearly 958 kPa (20,000 lb/ft²), the asphalt paving has the ability to remain watertight as the foundation settles under the load. Since 1963, more than 120 hm² (300 acres) have been paved for the leaching process.

Other asphalt pads have been constructed for similar copper leaching processes in Arizona and Nevada. Experimental pads varying from a sprayed-asphalt membrane on a compacted and primed subgrade to a 10-cm (4-in.) layer of asphalt concrete on the prepared subgrade followed by the asphalt membrane seal have been built.



FIGURE VIII-6. A beautiful asphalt panel lined pond in Scherer Park, Long Beach, California.

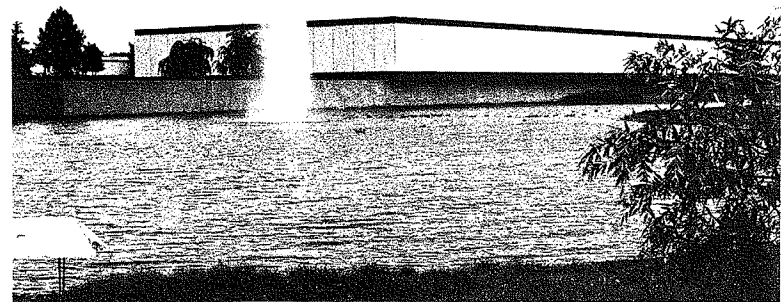

FIGURE VIII-7. Asphalt lined lagoon, Deering-Milliken Research Center, Spartanburg, South Carolina.

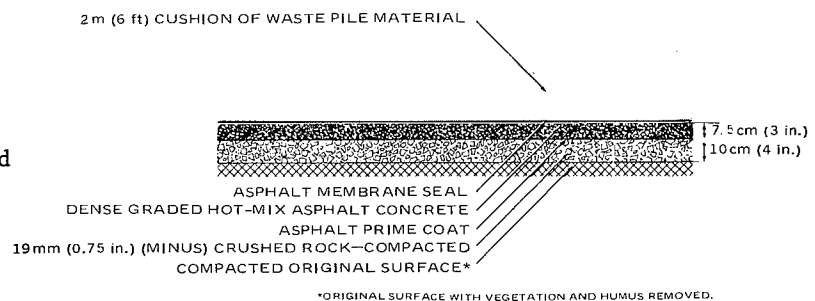

FIGURE VIII-8. Pavement cross-section of asphalt-paved recovery pad for leaching copper, Butte, Montana.

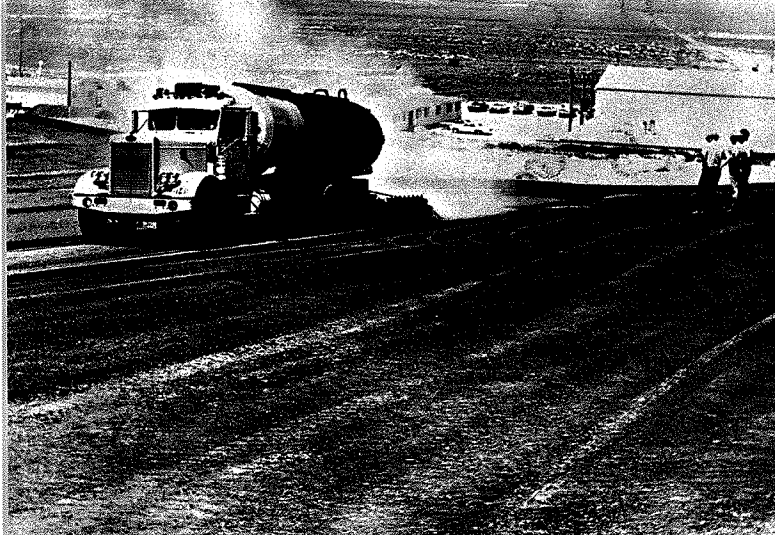

FIGURE VIII-9. Spraying asphalt membrane seal over asphalt concrete paved basin for leaching gold, Cortez, Nevada.

More recently, a similar process was developed for recovering gold from mine wastes. Here again, asphalt-paved pads are used to enable complete liquid recovery from the waste piles being treated. One such pad under construction is shown in Figure VIII-9, where a 6-mm (1/4-in.) asphalt membrane seal is being sprayed over the surface of a 7.5-cm (3-in.) layer of asphalt concrete for a gold recovery pad in Cortez, Nevada.

8.07 ASPHALT FOR WATER CATCHMENTS--The use of asphalt as a lining for water catchment areas is not new. Since 1958, techniques have been developed for low-cost water catchments with sprayed-asphalt coatings. Sprayed-asphalt coatings have proven satisfactory for providing drinking water for livestock and, after suitable treatment, for human consumption.

Several test sites have been constructed in Arizona and New Mexico. The largest was a 3.6-hm² (9-acre) catchment at the White

Sands Missile Range, New Mexico. Others have varied from 230 m² (2500 ft²) to slightly more than 0.8 hm² (2 acres) in size. Generally, the area to be used as a catchment basin has been cleared of vegetation, graded, smoothed, and compacted to the natural contours. In some cases the soil has been treated with a soil sterilant to prevent future growth of vegetation. The surface has then been primed with MC cutback asphalt, and sealed using a rapid-setting emulsified asphalt. Usually, the surface has then been sprayed with an asphalt-based aluminum paint.

There are several factors to be considered in selecting a water catchment site within a given area. Some of these are:

1. The annual rainfall should be at least 20 cm (8 in.), preferably 30 cm (12 in.) or more.
2. The natural grade should be at least 5 percent, but should not exceed 10 percent.
3. The soil should be sandy, free of excessively rocky areas, and have an expanding clay content of not more than 10 percent.

Selection of the type of asphalt for coating the surface is dependent upon the nature and texture of the soil. It is also advisable to test the soil by spraying a trial area adjacent to the site before treating the entire area. Properly constructed, the surface should be durable, relatively impermeable, and free from cracking. With suitable maintenance and early refurbishing, such catchments can be maintained indefinitely.

INDEX

A

- Abrasion as a design consideration, 11
- Application forms of asphaltic materials for hydraulic structures, 6
- Asbury Park, New Jersey asphalt jetty, 48-49
- Asphalt applications, types of, 13-23
 - Asphalt mastic mixes, 16-18
 - Buried asphalt membrane, 19-21
 - Impermeable asphalt concrete linings, 13-16
 - Miscellaneous, 22-23
 - Porous hot-mix asphalt linings, 16
 - Prefabricated asphalt panels, 21-22
 - Surface treatments, 18-19
- Asphalt-capped seawalls in California, 51-52
 - Asphalt concrete stabilizes stone seawall at Los Angeles Harbor, 51
 - Asphalt mastic grouted and capped stone seawall at Palos Verdes Estates, 51-52
- Asphalt cement in hydraulics and AC and AR systems of viscosity grading defined, 1-2
 - Penetration grades compared with viscosity grades, 2
- Asphalt concrete canal linings, 40-42
 - Construction, 40-42
 - Design, 41
 - Early history, 42
 - Equipment, 41-42
 - Thicknesses, 41
- Asphalt concrete, hydraulic type, definition and use, 2
- Asphalt concrete storm channels, 43-44
- Asphalt cutoff wall, Claytor Dam, Virginia, construction, design and mix details, 37-39
- Asphalt facing, definition and use, 2
- Asphalt grout, definition and use, 2
- Asphalt grouted gabions, 47-48
 - Asphalt mastic grout, poured, 47
 - Gabions, defined, 47
 - Installations in United Kingdom and Italy, 47-48
- Asphalt in bank protection, 45-48
 - Asphalt grouted gabions, 47-48
 - General, 45
 - Mississippi riverbank paving, 45-46
 - San Joaquin river, 46-47
- Asphalt in canals, 40-43
 - Asphalt concrete linings, 40-42
 - Buried asphalt membrane linings, 42-43
 - General, 41
 - Miscellaneous canal linings, 43
 - Prefabricated asphalt panel linings, 43
- Asphalt in coast protection structures, 49-53
 - Asphalt-capped seawalls in California, 51-52
 - Coastal protection, The Netherlands, 50-51, 52
 - Galveston Jetty, 49-50
 - General, 49
 - Port Austin breakwater, 49-50
 - Slope protection, 51, 53
- Asphalt in dam construction, 33-39
 - Asphalt injection for seepage control, 37-38
 - Claytor Dam asphalt cutoff wall, 37, 39
 - General, 33-34
 - Homestake Dam, 12, 34-37
 - Internal asphalt cores for dams, 37-38
 - Montgomery Dam, 34-35, 37
- Asphalt in hydraulic structures, xi-60
 - Asphalt applications, 13-39
 - Examples, 25-39
 - Types, 13-23
 - Bank protection, 45-48
 - Canals and drainage channels, 40-44
 - Coast protection, 48-53
 - Considerations for using asphalt, 5-12
 - Early history, 1
 - General principles, xi-23
 - Miscellaneous uses, 53-60
 - Technology advancement, 1
- Asphalt in miscellaneous uses, 55-60
 - Asphalt-lined ponds, 57-59
 - Asphalt-lined swimming pools, 56-57
 - Asphalt-lined waste treatment lagoons, 57, 59
 - Asphalt linings for sanitary landfills, 55-56
 - Asphalt-paved ore recovery pads, 59-60
 - Asphalt water catchments, 60
 - General, 55
- Asphalt injection, definition and use, 2
- Asphalt injection for seepage control, construction, design, and examples, 37-38
 - Great Falls Reservoir, Tennessee, 38
 - Morrow Point Dam, Colorado, 38
- Asphalt lining, definition and use, 2
- Asphalt linings for reservoirs, design, compacting and placement methods, and examples, 4, 26-31
 - Eastern Reservoir, Onondaga County (New York) Water District, 28-30
 - General, 27

Asphalt linings for reservoirs (cont.)

- Ludington, Michigan, pumped storage project, xii, 30-33
- Oakland, California, domestic water supply reservoirs, East Bay Municipal Utility District, 28-29
- Southern California, several filtered-water reservoirs in, 27-28

Asphalt linings for sanitary landfills, construction and design, 55-56

Asphalt mastic, definition and use, 2

Asphalt mastic mixes, 17-18

- Construction, 18
- Description, 16-17
- Design considerations, 17
- Mix design, 17-18
- Uses, 17

Asphalt mastic seals, 18

Asphalt mat

- Applications, 23
- Definition and use, 3

Asphalt materials, considerations for using in hydraulic structures, 5-7

- Properties, 5
- Types of and their function, 5-6
- Waterproofing, 5-7

Asphalt materials for protecting hydraulic structures, 6-7

- Asphalt mastics, 6-7
- Impermeable asphalt mixes, 6-7
- Porous asphalt mixes, 6-7
- Prefabricated asphalt materials, 6-7

Asphalt materials in hydraulic structures, relating terms, definition and use, 1-3

- Asphalt cement, 1
- Asphalt concrete, hydraulic type, 2
- Asphalt facing, 2
- Asphalt grout, 2
- Asphalt injection, 2
- Asphalt lining, 2
- Asphalt mastic, 2
- Asphalt mat, 3
- Asphalt mattress, 3
- Asphalt membrane, 3
- Asphalt mix, impermeable, 3
- Asphalt mix, open-graded, 3
- Asphalt mix, permeable, 3
- Asphalt mix, porous, 3
- Asphalt prefabricated panels
- Asphalt revetment, 3

Asphalt penetration macadam, 43

ASTM specification for asphalt in waterproof membrane, 20

B

Bank protection, 45-48

Breakwater, definition and use, 3

Brine storage asphalt reservoirs, 54, 47

Buried asphalt membrane, 19-21

- Construction, 19-21
- Description, 19
- Design considerations, 19
- Uses, 19

Buried asphalt membrane canal linings, cross-sections, history and purpose, 42-43

C

Canal, definition and use, 3

Canals, asphalt in, 40-43

Catchment basin, definition and use, 3

Causeway, definition and use, 3

Cavitation, definition and effect, 3

Channel, definition, 3

Coast protection with asphalt structures, 49-53

Compacting asphalt reservoir linings, methods of, 26-31

Compaction in considering design, 11

Composite structured reservoir, Oakland, California, 28-29

Composite use of asphalt materials, 8

Copper recovery from waste piles leachate on asphalt pads, 59

Cores, asphalt for dams, 37-38

D

Dam, definition, 3

Dam construction, general, 33-34

Definitions and use of terms relating to

- Asphalt materials, 1-2
- Hydraulic structures, 3-4

Design considerations for using asphalt, 8-11

- Abrasion, 11
- Compaction, 11
- Drainage, 9-10
- Slopes, 9-10
- Subgrade preparation, 8-9
- Surface protection, 11
- Thickness, 10-11
- Weed control, 9

Dike (levee) defined, 3

Drainage channels, asphalt construction, design, reinforcement and thickness, 43-44

Drainage in considering design, 9-10

Drinking water stored in asphalt-lined structures, hygienic qualities of, 5

E

Early history of asphalt in hydraulics, 1

Eastern Reservoir, Onondaga County (New York) Water District, construction, design and equipment, 28-30

Embankment, definition and use, 3

F

Function of asphaltic materials, application forms, 6

"Futurama" pool at General Motors' World's Fair exhibit, 58

G

Gabions, defined, 47

Galveston, Texas, jetty sealed and capped with asphalt mastics, 49-50

Garvey Reservoir, construction and equipment, 26-27

Gold recovery from mine waste leachate on asphalt pads, 59-60

Great Falls, Tennessee reservoir leakage controlled by asphalt injection, 38

Groin, definition and use, 3

Grouting and capping seawalls, 51

Grouted gabions with asphalt, 47-48

H

History and background of asphalt in hydraulics, 1

Homestake Dam, Colorado, construction methods, design, and mix formula, 12, 34-37

Hydraulic structures and relating terms, definition and use, 3-4

Breakwater, 3

Canal, 3

Catchment basin, 3

Causeway, 3

Cavitation, 3

Channel, 3

Dam, 3

Dike, 3

Embankment, 3

Groin, 3

Jetty, 3

Lateral, 3-4

Levee, 4

Pond, 4

Reservoir, 4

Riprap, 3

Sanitary landfill, 4

Seawall, 4

Sewage lagoon, 4

I

Impermeable asphalt concrete linings, 13-16

Construction, 14-16

Description, 13

Impermeable asphalt concrete linings (cont.)

Design considerations, 13

Mix designs, 13-15

Uses, 3, 13

Industrial waste ponds, 57

Injecting subsurface with asphalt, 22-23

Innerste Dam, Germany, asphalt lining construction, 26

Internal asphalt cores for dams, construction, designs, mix types and recent special machinery, 26, 37-38

J

Jetty

Coast protection, general, 49

Definition and use, 3

Galveston, 49-50

K

Kerkhoven, R. E., 52

L

Lagoons, asphalt-lined, 57, 59

Lateral, definition and use, 3-4

Leachates, control of in asphalt linings for sanitary landfills, 55

Levee, definition, 4

Ludington, Michigan, pumped storage reservoir, construction, design, equipment and job-mix formula, xii, 30-33

M

Maryland Point Lookout Causeway, asphalt revetment for seaside slope protection, 51, 53

Mattress, asphalt, applications, 23

Miscellaneous asphalt canal linings

Asphalt penetration macadam, 43

Pneumatically-applied asphalt sand mix with emulsified asphalt, 43

Undersealing as rehabilitation of old concrete canal linings, 43

Miscellaneous types of asphalt applications, 22-23

Asphalt-coated mats, 23

Asphalt injection, 22-23

Asphalt mattresses, 23

Asphalt prime treatments, 22

Asphalt underseal, 23

Sand asphalt mixes, 22

Waterborne asphalt sealants, 22

Miscellaneous uses of asphalt, 55-60

Mississippi riverbank paving
 Subaqueous placement of reinforced
 asphalt mattress, 45-46
 Upper bank paving of porous, uncompacted
 sand asphalt mix, 46
Mix compositions for formed-in-place asphalt
linings, 15
Montgomery Dam, Colorado, construction,
design and asphalt concrete mix formula,
34-35, 37
Montpelier, Vermont, swimming pool, 57
Morrow Point Dam, asphalt emulsion with
lime slurry plugs leakage channels, 38

N

Netherlands coastal protection, 50-51, 52
Non-asphalt surface treatment cement wash,
purpose and solution, 18-19

O

Oakland (California) Reservoir composite
structure design, 28-29
Open-graded asphalt mixes, definition and
use, 3
Ore recovery pads, asphalt-paved, construc-
tion and designs, 59-60

P

Paints for asphalt-lined pools, 56
Penetration grades of asphalt cement compared
with viscosities of AC and AR systems, 2
Permeable asphalt mixes, definition and use,
3
Placement of asphalt reservoir linings,
methods of, 26-31
Pond, defined, 4
Ponds, asphalt lined, designs and uses,
57-59
Porous hot-mix asphalt linings, 15-16
 Construction, 16
 Description, 16
 Mix design, 15-16
 Uses, 16
Port Austin, Michigan, breakwater, 133 steel
cells capped by sand-asphalt mixes, 49-50
Prefabricated asphalt panels
 Construction, 21-22
 Definition and use, 3
 Description, 21
 Early history and purpose, 43
 Uses, 21
Prime treatment applications, 22

Properties of asphalt materials, 5
Pumped storage reservoir, Ludington,
Michigan, xii, 30-35

R

Reading, Pennsylvania, asphalt membrane type
of sanitary landfill, 55
Reflecting pool, Long Beach, California,
asphalt prefabricated panel construction,
58
Reservoir asphalt linings, general, 27
Revetments, asphalt
 Definition and use, 3
 Designs and durability, 45-48
Riprap, definition and use, 4
Rockford, Illinois, asphalt concrete type of
sanitary landfill, 55

S

Sand asphalt application type, 22
Sand and emulsified asphalt mixture
pneumatically-applied canal lining, 43
Sanitary landfill
 Definition and use, 4
 Designs and examples, 55-56
San Joaquin river, California, revetment
construction, design and record of asphalt
concrete sections, compacted and uncom-
pacted, 46-47
San Joaquin, California, reservoir,
construction and equipment, 4, 26-27
San Pablo, California, clear water reservoir
relined with asphalt prefabricated panels
and cold-applied asphalt mastic joint
filler to leaking rigid lining, 28
Sealants, waterborne asphalt applications, 22
Seawalls, asphalt grouted and capped, 51
Seepage control by asphalt injection, 37-38
Sewage lagoons, construction and designs, 57
Shell International Petroleum Co. Ltd.,
photographs, 26, 38
Slope protection of seaside and seawall
structures, with asphalt, 51, 53
Slopes in considering design, 9-10
Southern California asphalt-lined reservoirs,
construction and design, 27-28
Spartanburg, South Carolina, asphalt-lined
lagoon, 59
Sprayed asphalt seals, 18
Storm channels, 43-44
Subaqueous placement of asphalt, 45-46, 51-52
Subgrade preparation in considering design,
8-9
Surface protection in considering design, 11

Surface treatments, 18-19
Asphalt mastic seals, 18
Non-asphalt, 18-19
Purposes, 18
Sprayed asphalt seals, 18
Swimming pools, asphalt lined, construction
and designs, 56-57

T

Thickness factors in considering design,
10-11
Tigris embankment at Assur, construction, 1

U

Undersealing old concrete canal linings
with asphalt, 43
U. S. Bureau of Reclamation asphalt projects,
references to, 38, 41-43, 57
U. S. Army Corps of Engineers, asphalt
projects, references to, 23, 45-47, 49

V

Viscosity grading of asphalt cements by AC
and AR systems
Defined, 1-2
Penetration grades compared with, 2

W

Wading pools, asphalt linings, 56
Wallingford, Connecticut, asphalt swimming
pool, 56
Warren, Pennsylvania, upper reservoir,
construction, design, and asphalt mastic
formula, 30-31
Waste-treatment lagoons, asphalt-lined, 57,
59
Waterborne asphalt sealants, 22
Water catchments, asphalt lining construction,
design and potability, 60
Water, drinking quality, 59
Weed control in considering design, 9

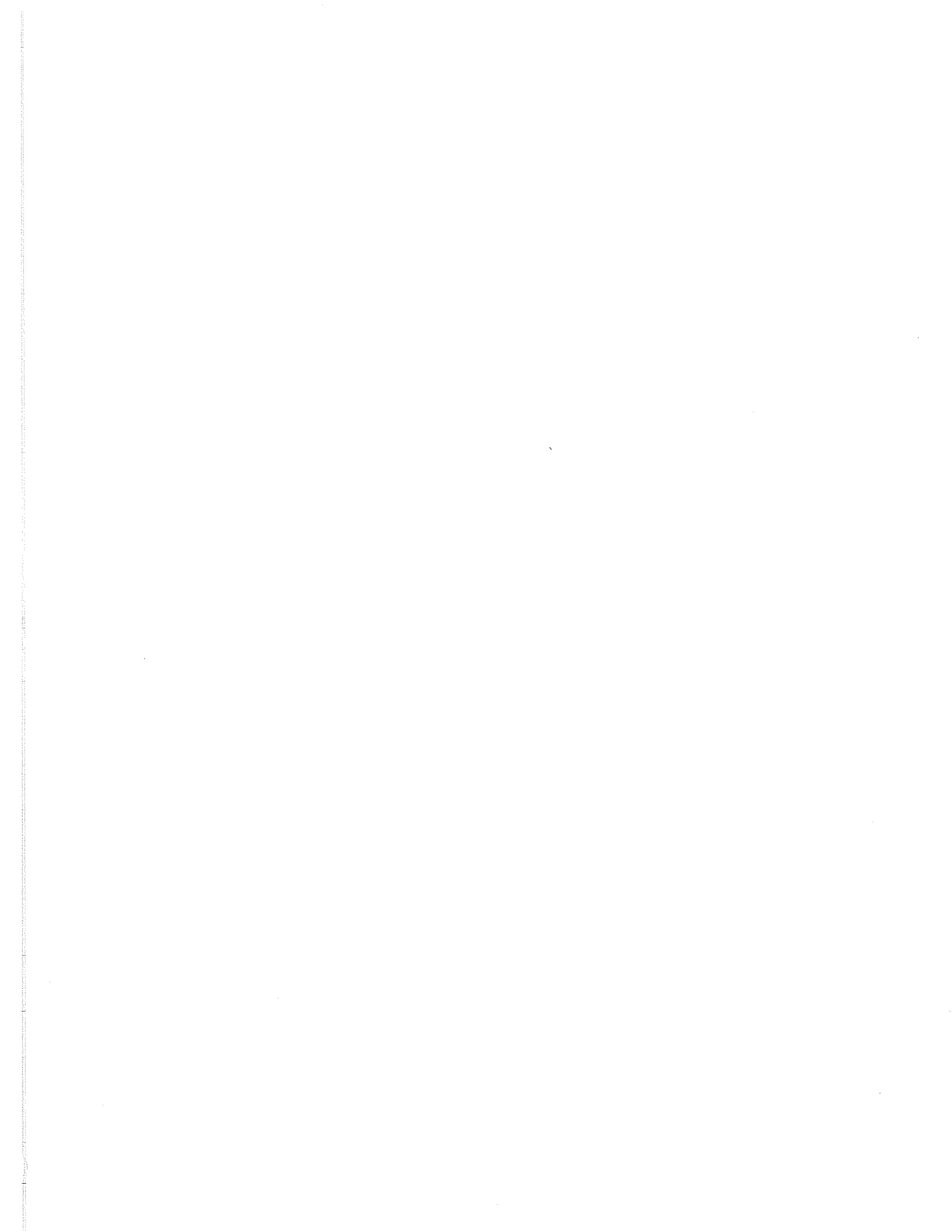

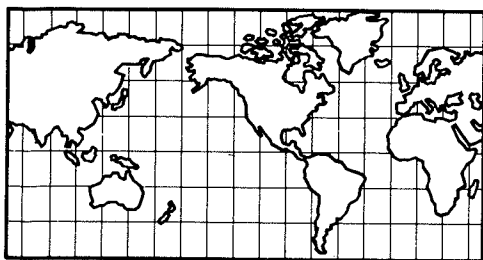

THE ASPHALT INSTITUTE

EXECUTIVE OFFICES AND RESEARCH CENTER

Asphalt Institute Building
College Park, Maryland 20740



MEMBERS OF THE ASPHALT INSTITUTE (As of March 1, 1979)

The Asphalt Institute is an international, nonprofit association sponsored by members of the petroleum asphalt industry to serve both users and producers of asphaltic materials through programs of engineering service, research and education. Membership is limited to refiners of asphalt from crude petroleum, and to processors manufacturing finished paving asphalts and/or non-

paving asphalts but not starting from crude petroleum. Institute Members provide quality products and advocate quality construction and timely maintenance. A total of 55 Members have headquarters in offices in:

United States	38	Europe	6
Canada	6	Middle East	3
South America	1	Asia	1

- ALLIED MATERIALS CORPORATION, Oklahoma City
- AMOCO OIL COMPANY, Chicago
- ASFALTOS ESPANOLAS, S.A., Madrid, Spain
- ASHLAND OIL, INC., Ashland, Kentucky
- ASPHALT MATERIALS, INC., Indianapolis
- ATLANTIC RICHFIELD COMPANY, Philadelphia
- BP OIL LIMITED, Montreal, Quebec, Canada
- THE BRITISH PETROLEUM COMPANY, LIMITED, London, England
- BYERLYTE COMPANY OF KOPPERS COMPANY, INC., Pittsburgh
- CENEX, Laurel, Montana
- CHEVRON U.S.A. INC., San Francisco
- COMPANIA ESPANOLA DE PETROLEOS, S.A., Madrid, Spain
- CONTINENTAL OIL COMPANY, Houston
- DELTA REFINING COMPANY, Memphis, Tennessee
- DOUGLAS OIL COMPANY OF CALIFORNIA, Los Angeles, Costa Mesa
- EDGINGTON OIL COMPANY, INC., Long Beach, California
- ENERGY COOPERATIVE, INC., Chicago
- EXXON COMPANY, U.S.A., Houston
- EXXON CORPORATION, New York
- GULF OIL CANADA LIMITED, Toronto, Ontario, Canada
- HUNT OIL COMPANY, Dallas
- HUSKY OIL OPERATIONS LTD., Calgary, Alberta, Canada
- IMPERIAL OIL LIMITED, Toronto, Ontario, Canada
- INDUSTRIA ITALIANA PETROLI SpA, Genoa, Italy
- JORDAN PETROLEUM REFINERY COMPANY LTD., Amman, Jordan
- KERR-McGEE REFINING CORPORATION, Oklahoma City
- KOCH ASPHALT COMPANY, Wichita, Kansas
- LAGOVEN, S.A., Caracas, Venezuela
- LAKETON ASPHALT REFINING, INC., Evansville, Indiana

- MACMILLAN RING-FREE OIL CO., INC., El Dorado, Arkansas
- MARATHON OIL COMPANY, Findlay, Ohio
- MOBIL OIL CORPORATION, New York
- MOBIL OIL CORPORATION—International Division, New York
- NATIONAL IRANIAN OIL COMPANY, Tehran, Iran
- NATIONAL REFINERY LIMITED, Karachi, Pakistan
- NEWHALL REFINING CO., INC., Newhall, California
- AB NYNAS PETROLEUM, Stockholm, Sweden
- OXNARD REFINING COMPANY, Oxnard, California
- PAZ OIL COMPANY LTD., Haifa, Israel
- PETROFINA CANADA LTD., Montreal, Quebec, Canada
- PHILLIPS PETROLEUM COMPANY, Bartlesville, Oklahoma
- POWERINE OIL COMPANY, Santa Fe Springs, California
- SEMINOLE ASPHALT REFINING, INC., St. Marks, Florida
- SHELL CANADA LIMITED, Toronto, Ontario, Canada
- SHELL INTERNATIONAL PETROLEUM COMPANY LIMITED, London, England
- SHELL OIL COMPANY, Houston
- SOUTHLAND OIL COMPANY, Jackson, Mississippi
- SUN PETROLEUM PRODUCTS COMPANY, Philadelphia
- THE STANDARD OIL COMPANY (Ohio), Cleveland
- TOSCO CORPORATION, El Dorado, Arkansas
- TOTAL PETROLEUM, INC., Alma, Michigan
- U.S. OIL & REFINING COMPANY, Los Angeles
- VULCAN REFINING COMPANY, Cordova, Alabama
- WARRIOR ASPHALT COMPANY OF ALABAMA, INC., Tuscaloosa, Alabama
- WITCO CHEMICAL CORPORATION—Golden Bear Division, Los Angeles; Pioneer Division, New York

ASPHALT INSTITUTE ENGINEERING OFFICES (As of March 1, 1979)

EASTERN DIVISION

- WASHINGTON, D.C. 20014—4733 Bethesda Ave., (301) 654-5324, Connecticut, Delaware, District of Columbia, Kentucky, Maine, Maryland, Massachusetts, New Hampshire, New Jersey, New York, Ohio, Pennsylvania, Rhode Island, Vermont, Virginia, West Virginia
- NEW YORK, N.Y.—(Address: 20 Evergreen Place, East Orange, N.J. 07018), (201) 676-3838, New York City, Westchester Co., Long Island, Delaware, New Jersey
- SYRACUSE, N.Y. 13066—7000 E. Genesee St., Fayetteville, N.Y. (315) 445-1333, New York State except New York City, Westchester County, Long Island
- BOSTON, MASS.—(Address: 599 North Ave., Drawer 9, Wakefield 01880), (617) 245-6046, Connecticut, Maine, Massachusetts, New Hampshire, Rhode Island, Vermont.
- HARRISBURG, PA. 17109—13 North Progress Ave., (717) 545-4713, Pennsylvania
- COLUMBUS, OHIO 43215—41 S. High St., Suite 101, (614) 224-3265, Ohio
- LOUISVILLE, KY. 40207—4050 Westport Rd., (502) 895-6966, Kentucky, West Virginia
- RICHMOND, VA. 23230—2120 Staples Mill Road, (804) 353-3826, District of Columbia, Maryland, Virginia

SOUTHERN DIVISION

- JACKSON, MISS. 39206—415 Comet Drive, Suite 3, (601) 981-3417, Alabama, Arkansas, Florida, Georgia, Louisiana, Mississippi, North Carolina, Oklahoma, South Carolina, Tennessee, Texas (except El Paso area)
- AUSTIN, TEXAS 78723—1106 Clayton Lane, Suite 109 W, (512) 454-7927, Eastern Texas
- NORTH LITTLE ROCK, ARK. 72116—P.O. Box 4007 (5318 John F. Kennedy Blvd.), (501) 758-0484, Arkansas, Oklahoma
- MONTGOMERY, ALA. 36104—800 South McDonough St., (205) 264-3588, Alabama, Tennessee (except Memphis)
- TALLHASSEE, FLA. 32303—2639 North Monroe, Sta. 15, (904) 385-7822, Florida, Georgia
- RALEIGH, N.C. 27605—2016 Cameron St., (919) 828-5998, North Carolina, South Carolina

NORTHERN DIVISION

- CHICAGO, ILL. 60018—2400 E. Devon Ave., Suite 254, Des Plaines (312) 297-5907, Colorado, Idaho, Illinois, Indiana, Iowa, Kansas, Michigan, Minnesota, Missouri, Montana, Nebraska, North Dakota, South Dakota, Utah, Wisconsin, Wyoming
- INDIANAPOLIS, IND. 46240—1010 E. 86th St., (317) 846-9146, Indiana
- MINNEAPOLIS, MINN. 55422—6100 Golden Valley Rd., Suite 113, (612) 546-2311, Minnesota, Wisconsin
- HELENA, MONTANA 59601—1111 North Rodney, (406) 442-9100, Idaho, Montana, North Dakota
- JEFFERSON CITY, MO. 65101—400 East High St., Suite 305, (314) 635-1181, Missouri (except St. Louis County), Kansas
- OMAHA, NEBR. 68132—6901 Dodge St., Room 105, (402) 556-4811, Nebraska, Iowa, South Dakota
- DENVER, COLO. 80215—1401 Salsbury, Suite 205, (303) 238-3411, Colorado, Utah, Wyoming
- LANSING, MICH. 48912—416 Frandor Ave., Suite 205, (517) 351-6543, Michigan
- SPRINGFIELD, ILL. 62704—1035 Outer Park Dr., Suite 413, (217) 787-7058, Illinois (outside of Chicago), St. Louis County, Missouri

PACIFIC COAST DIVISION

- SACRAMENTO, CALIF. 95815—1796 Tribute Road, (916) 922-6507, Alaska, Arizona, California, Hawaii, Nevada, New Mexico, Oregon, Western Texas (El Paso area), Washington
- LOS ANGELES, CALIF.—(Address: 4201 Long Beach Blvd., Suite 230, Long Beach 90807), (213) 427-7985, Southern California
- PHOENIX, ARIZ. 85016—3625 N. 16th St., (602) 266-2516, Arizona, New Mexico, Western Texas
- PORTLAND, ORE. 97005—Park Plaza West, Suite 322, 10700 SW Beaverton-Hillsdale Highway, Beaverton, (503) 643-4111, Oregon
- OLYMPIA, WASH. 98501—120 Union Avenue Building, (206) 943-0320, Alaska, Washington

NOTES